

The
HYDE
11 BALMORAL



A LUXURIOUS POINT OF VIEW

The Hyde is an oasis of tranquillity fronting Goodwood Hill, right next to the sparkle and excitement of the renowned Orchard Road. Its location at District 10 makes it a coveted address for the discerning few.

NATURE
ART
LUXURY

Tucked away in Goodwood Hill is a laidback escape from the busy city life. Created by award-winning developer Aurum Land, The Hyde melds modern life and its luxuries with the grace of nature into a living statement of art.

Inspired by the avant-garde approach of the Serpentine Pavilions set in Hyde Park, UK,

The Hyde is an aesthetic construct balancing harmoniously against a backdrop of abundant nature. Full height glazed façades and sashless windows translate into uninterrupted and expansive views. The Hyde is an invitation to living without borders, accented by elegance.

B SERPENTINE GALLERY
Inspiration
Photo by Fritz Haeg



AN ENCLAVE OF DISCREET PRESTIGE

Every aspect of The Hyde emanates quiet privilege. It stands apart through its sleek, sculptural and distinctive profile. Meticulously landscaped with lush tropical foliage to provide subtle screening, The Hyde offers a peaceful and serene environment. In addition, smart home systems with multiple levels of security provides homeowners and their designated guests diplomat-level privacy. From the grounds to the rooftop, The Hyde creates an enchanting reality that connects homeowners.



ARCHITECT'S STATEMENT













The Hyde sits on a prime site in the city. A mere turn away from Orchard Road, you arrive at a completely different world — an enclave of greenery, immense mature trees, birdsong and idyllic repose. We were immediately inspired by this.



We designed the architecture of The Hyde decidedly modern. Sleek clean lines complement the park-like surroundings and aspire to a refined quality of space and details — the new measure of luxury.

Apartments are elevated high off ground for commanding panoramic views of Goodwood Hill. This allows almost the entirety of the site to be freed up for greenery and common facilities. Amenities are nestled amidst nature, envisioned as bold but simple forms that reimagine convention and coalesce architecture, art and landscape.

FDAT Architects

LOCATION MAP

-  CLUBS
-  COMMUNITY CENTRES
-  EATERIES
-  EDUCATIONAL INSTITUTIONS
-  EMBASSIES
-  HOTELS
-  MEDICAL SERVICES
-  NPC
-  OFFICES
-  PARKS
-  RETAIL MALLS

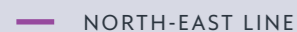
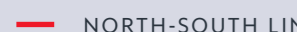
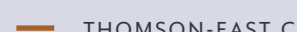
-  CIRCLE LINE (CCL)
-  DOWNTOWN LINE (DTL)
-  NORTH-EAST LINE (NEL)
-  NORTH-SOUTH LINE (NSL)
-  THOMSON-EAST COAST LINE (TEL)

INFORMATION IS CORRECT AT TIME OF PRINT

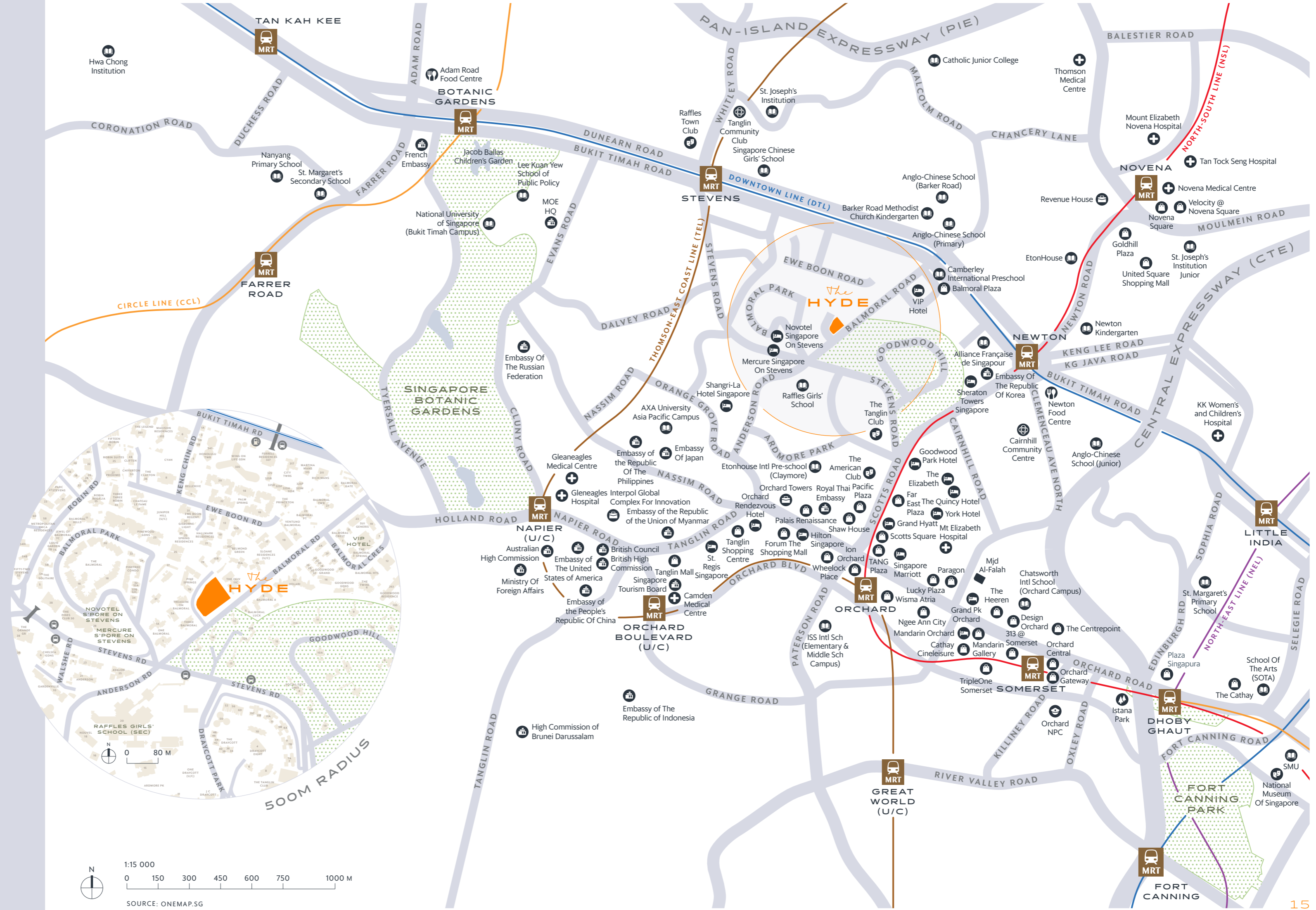



PARKS & GREENERY



PARKS

Goodwood Hill
Singapore Botanic Gardens
Malcolm Park
Fort Canning Park

L SINGAPORE BOTANIC GARDENS

From the soothing views of Goodwood Hill's foliage to nature-infused recreation at the Singapore Botanic Gardens 2km away, lush pockets of green are easily accessible to you. Delight in outdoor leisure like picnics and evening strolls, or healthy pursuits such as running and group fitness activities. The holistic benefits of the surrounding parks and greenery are for everyone in the family.



A LOVE LOCAL

Entertain visitors with the best local street hawkers at Newton and Adam Road Food Centre, with an al fresco experience of grilled seafood and other local favourites.

B HIGH-TEA AFTERNOONS

Spend time with loved ones over a spread of delectable cakes and tea, serviced by some of the best kitchen and wait staff. Whether it's at prestigious hotels or exclusive clubs, every meal is a delightful social affair.

C FINE DINE & WINE

Michelin-starred and highly acclaimed restaurants are dotted within the vicinity. From the dazzling Orchard Road to the hidden enclave of Dempsey Hill, indulge in cuisines from diverse parts of the world.



VISTA OF FLAVOURS

Satiate hunger with culinary offerings besides the spread of restaurants and cafes at the shopping districts. From popular local cuisines, gastronomic foods to fine dining, there is something for everyone.





L ACS (PRIMARY)
Photo by SAA Architects

THE GLAMOROUS LIFE

Orchard Road is a major belt of retail splendour and tourist attractions. Dotted with iconic buildings and luxurious hotels, this boulevard has everything for all your material desires. High street fashion, world-class restaurants, theatres, and entertainment centres such as an indoor urban playground, and a hyper-reality experience.

Orchard Road offers the ultimate shopping and lifestyle experience. Also within vicinity are the establishments of distinguished clubs boasting exclusive memberships and excellent facilities for social and recreational activities. With an array of engaging offerings, your neighbourhood is a charming spectacle of life's pleasures.

THE NEIGHBOURHOOD

AN ESTEEMED EDUCATION

Raise your next generation towards a life of passion, purpose and success. With some of the nation's best schools within The Hyde's vicinity, a prestigious education is at your doorstep.

A CHOICE PICK OF SCHOOLS

WITHIN 1KM

- Anglo-Chinese School (Primary)*
- Singapore Chinese Girls' Primary School*

1KM TO 2KM

- Raffles House Preschool*
- Barker Road Kindergarten*
- Eton House Preschool*
- St Margarets' Primary School*
- Anglo-Chinese School (Junior & Barker Road)*
- St. Joseph's Institution (Junior & Secondary)*
- Catholic Junior College*



SHOPPING MALLS

- ION Orchard*
- Tanglin Mall*
- TANG Plaza*
- The Paragon*
- Ngee Ann City*

CHOICE OF CLUBS

- Tanglin Club*
- The American Club*
- Raffles Town Club*

CREATING CONNECTIONS



Strategic location on Balmoral Road means easy connections to the CTE, PIE, and Orchard Road. Be in the centre of a wide network of connectivity and convenience. With Stevens and Newton MRT stations just minutes away and all the major bus routes serving the vicinity of The Hyde, public commute is accessible and

convenient for all. The cluster of embassies in the area also translates into high connectivity. Besides the possibilities of enhanced cross-border relations and smoother work processes, be assured that your home is in the heart of security and exclusivity.

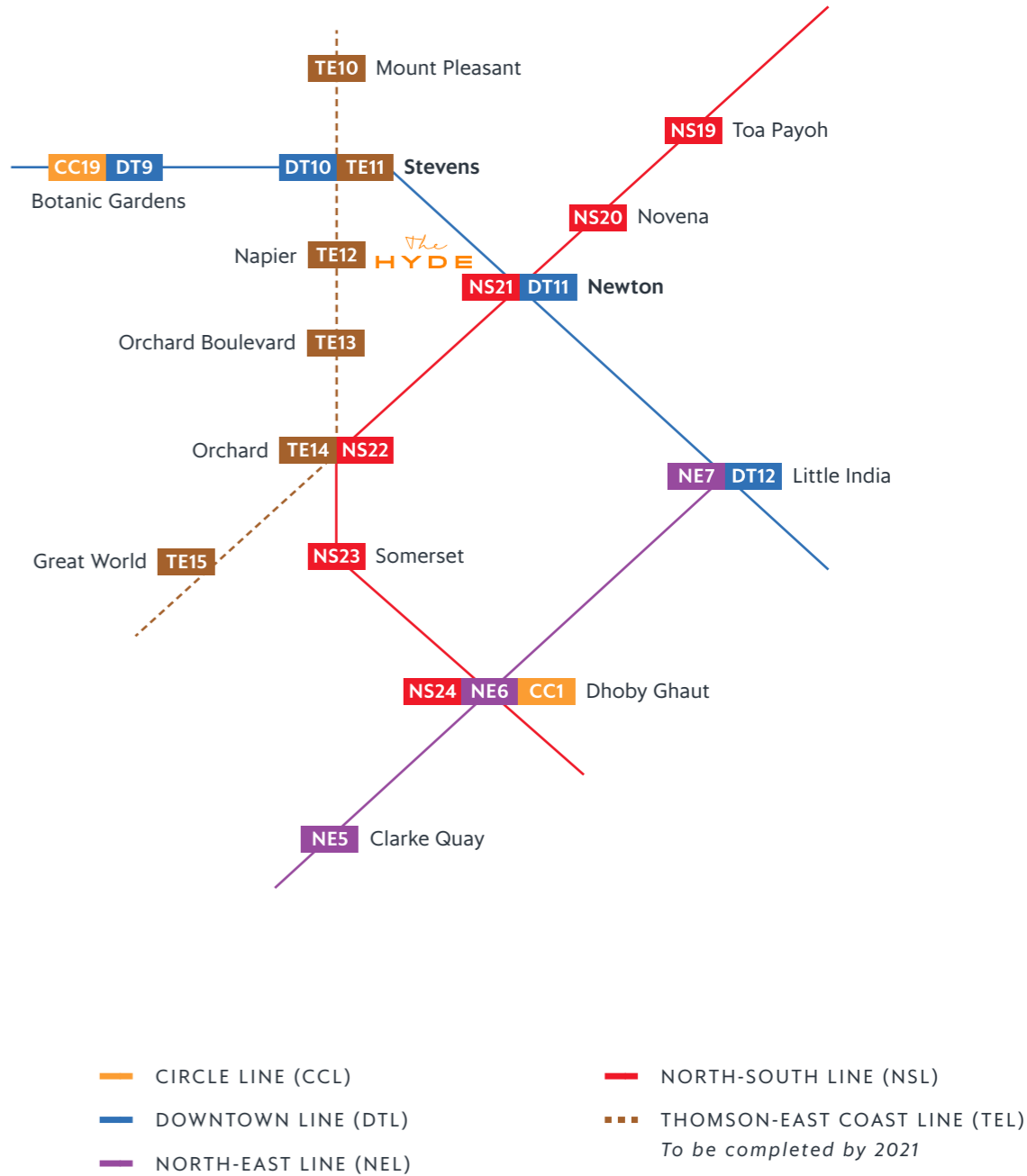



ARTIST'S IMPRESSION

ENTER THE GALLERY

A terraced garden. Grand pillars. Contemporary lines. It's a picture of art, a statement of class, from the start. An awe-inspiring entrance with promise for more, together with offerings of concierge services and modern amenities like a smart-parcel collection station.

Dive deep into the celestial with the Constellation Pool, a 50m lap pool inspired by one of the most iconic Serpentine Pavilions. Constellations in LED

are impressed into the pool's floor, reflecting the sky above and focusing your gaze onto nature no matter where you look during the night.



ARTIST'S IMPRESSION



T GARDEN CLUB

CELEBRATING IN STYLE

Embraced by a sculpted landscape, with the statement pool as the centrepiece. The Garden Club is the perfect place to create and celebrate moments in the relaxing arms of nature.



STIMULATING PLAY

Let children learn the interactive way surrounded by the pulse of nature. From the timeless delights of swings and slides to the exciting challenge of a climbing wall to a childhood dream of a treehouse, the Playground is readily equipped for the best exploratory fun.

T
R

PLAYGROUND
GYMNASIUM



HOLISTIC FITNESS

The Gymnasium is more than a place for physical conditioning. With a view of the pool and surrounding greenery, it's a place to exercise all senses; a conducive environment for holistic health.

A LANDSCAPE OF LUXURIES

A haven of abundant nature and refined luxuries, against a panorama of urban comforts. Live minutes away from elite schools, prestigious private clubs, world-class medical centres and a vibrant district of retail and hospitality galore.

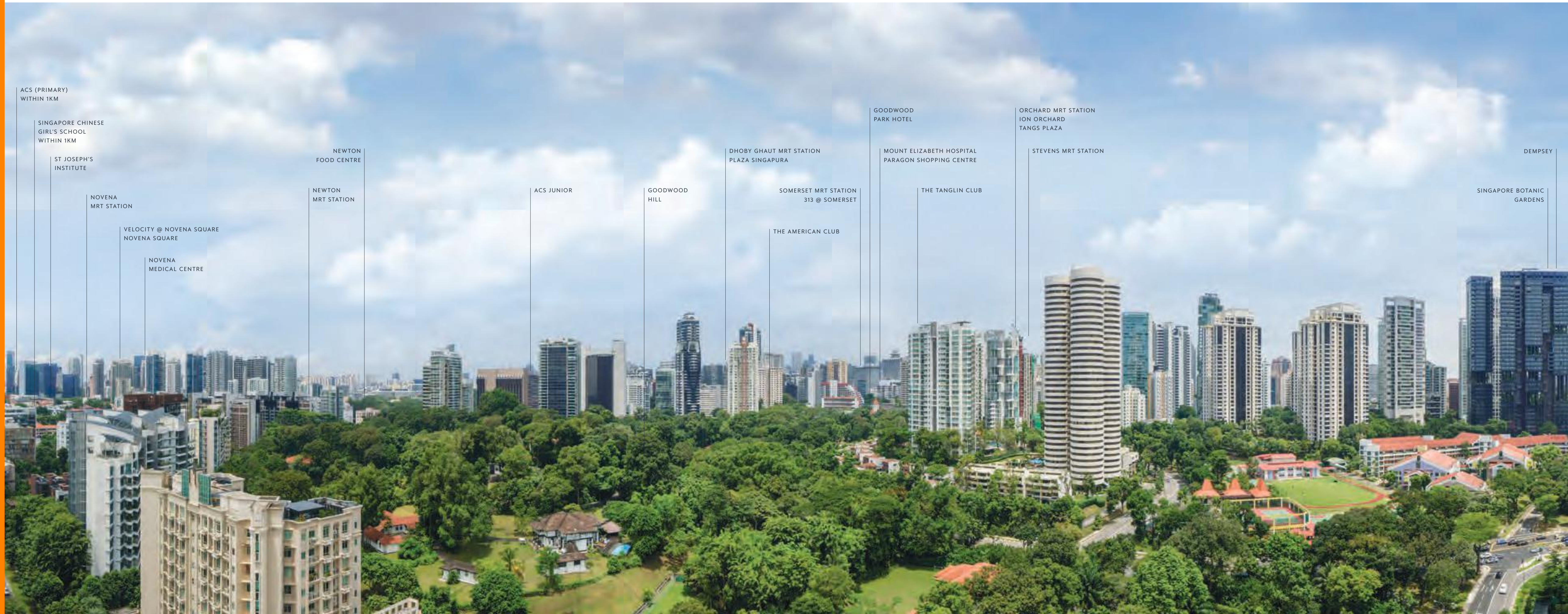

R AERIAL VIEW
Taken from 11 Balmoral Road, The Hyde



NEW LEVEL OF ENJOYMENT

Take your leisurely pursuits to another level at the Roof Terrace, with facilities set against a breath-taking backdrop.

The cantilevered clubhouse reaches out to nature, and the Sky Pool and Sky Deck sit on an infinity edge, blending into the horizon beyond.



ARTIST'S IMPRESSION



A FRONT-SEAT VIEW

The spacious and elegant living room extends into nature. Its full height glazing generously welcomes natural light and a scenic canvas of greenery. It is a near seamless invitation of nature into the hearth of your home.

ARTIST'S IMPRESSION



ARTIST'S IMPRESSION

A HOME OF SMART COMFORTS

Flourish in luxury by living smart, with selected smart home devices. Selected units will enjoy private lift lobby access direct to their home.

A

VIDA GATEWAY
Use the built-in pan & tilt camera and connection to other smart devices to monitor your home all day.



B

SMART LOCK SET
Secure the entrance with a pin code and biometric fingerprint. Be further assured with features such as warning alarms, automatic locking, manual override, and unlock remotely with the mobile app.



C

IP CAMERAS
Monitor different parts of the house with cameras equipped with sensors, built-in microphone, and speaker.



D

iPLUS MOBILE APP
Access smart home devices, monitor home, and book facilities at The Hyde, or pre-register visitors for QR code access — all in one app.





ARTIST'S IMPRESSION



ARTIST'S IMPRESSION

- L MASTER BEDROOM
- T MASTER BATHROOM

PRIVATE OASIS

An expansive view of Goodwood Hill. Timber-strip flooring for the bedroom. Granite and marble for the bath, with fixtures by Gessi and Laufen. The textures of nature flows into all spaces, including your personal sanctuary.

LEVEL 1

- | | | |
|----------------|--------------------------------|--------------------|
| 1 GUARDHOUSE | 9 CONSTELLATION POOL | 17 BOARDWALK |
| 2 SIDE GATE | 10 POOLSIDE CABANAS | 18 WADING POOL |
| 3 DROP OFF | 11 SUN LOUNGE DECK | 19 SOCIAL PAVILION |
| 4 THE PLAZA | 12 CHANGING ROOM & RAIN SHOWER | 20 PLAYGROUND |
| 5 PLAYROOM | 13 SECRET POOL & JACUZZI | 21 WASHROOM |
| 6 GYMNASIUM | 14 GARDEN CLUB | 22 CONCIERGE |
| 7 BBQ PAVILION | 15 YOGA DECK | 23 BICYCLE PARKING |
| 8 THE LAWN | 16 LAWN SCULPTURE | |



PLAN IS NOT DRAWN TO SCALE
ARTIST'S IMPRESSION

SKY TERRACE

- | |
|----------------|
| 24 SKY DECK |
| 25 SKY POOL |
| 26 RAIN SHOWER |
| 27 SKY CLUB |
| 28 SKY GARDEN |
| 29 WASHROOM |



PLAN IS NOT DRAWN TO SCALE
ARTIST'S IMPRESSION

DIAGRAMMATIC CHART

UNIT	01	02	03	04	05	06	07	08	09	10	11
12 TH STOREY	B1P	A1P	C1P	B3P	C2P	A1P (M)	B2P	DP	A2P	B3P	B4P
11 TH STOREY	B1	A1	C1	B3	C2	A1 (M)	B2	D	A2	B3	B4
10 TH STOREY	B1	A1	C1	B3	C2	A1 (M)	B2	D	A2	B3	B4
9 TH STOREY	B1	A1	C1	B3	C2	A1 (M)	B2	D	A2	B3	B4
8 TH STOREY	B1	A1	C1	B3	C2	A1 (M)	B2	D	A2	B3	B4
7 TH STOREY	B1	A1	C1	B3	C2	A1 (M)	B2	D	A2	B3	B4
6 TH STOREY	B1	A1	C1	B3	C2	A1 (M)	B2	D	A2	B3	B4
5 TH STOREY	B1	A1	C1	B3	C2	A1 (M)	B2	D	A2	B3	B4
4 TH STOREY	B1	A1	C1	B3	C2	A1 (M)	B2	D	A2	B3	B4
3 RD STOREY	B1	A1	C1	B3	C2	A1 (M)	B2	D	A2	B3	B4
2 ND STOREY			C1	B3	C2			D	A2	B3	B4

■ 1 BEDROOM
 ■ 2 BEDROOM
 ■ 3 BEDROOM
 ■ 4 BEDROOM

UNIT FLOOR PLANS

**TYPE A1
1 BEDROOM**

AREA 46 sqm | 495 sqft

UNITS Type A1(a) #03-02, #06-02, #09-02
 Type A1(b) #04-02, #07-02, #10-02
 Type A1(c) #05-02, #08-02, #11-02

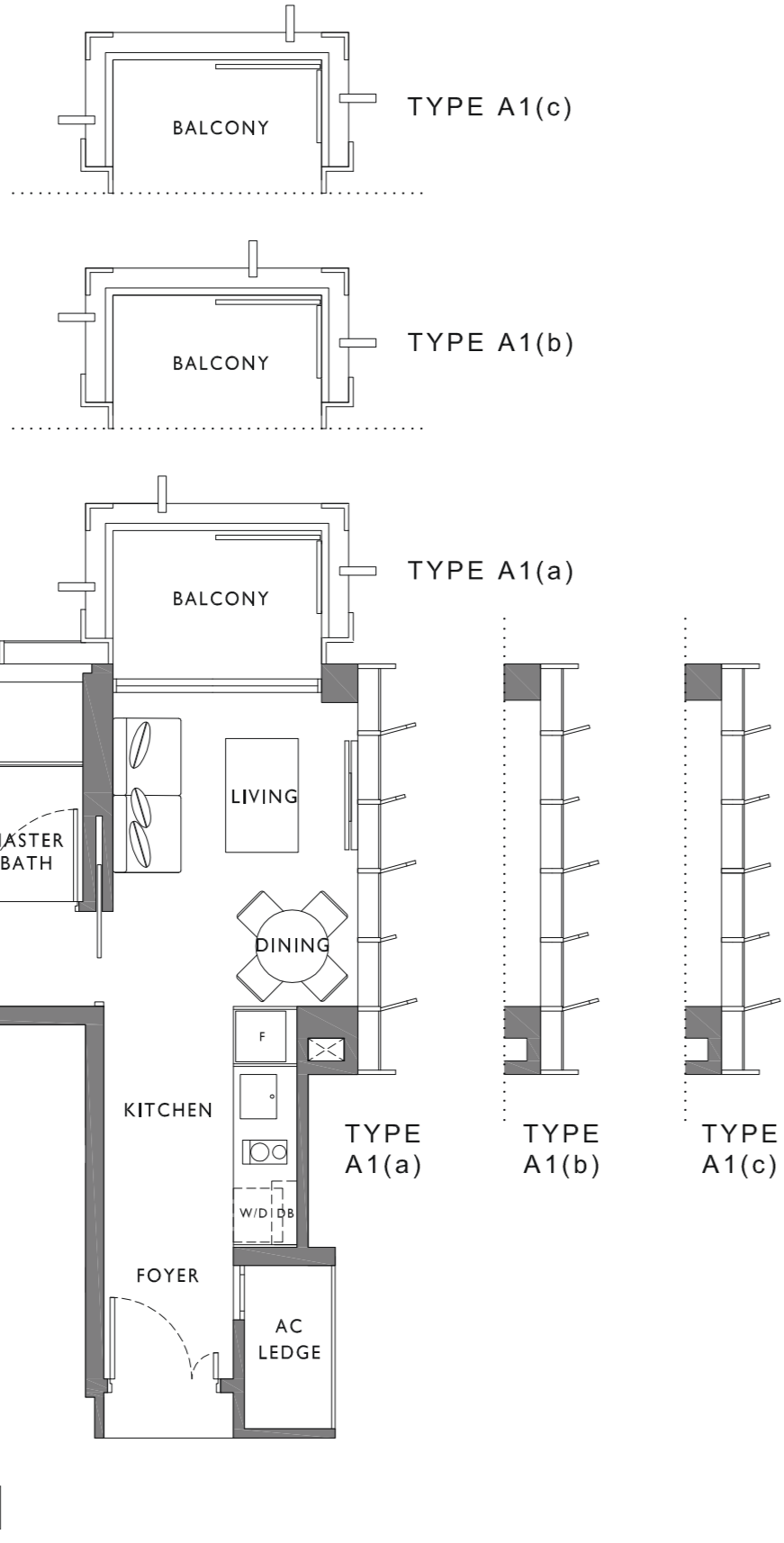

**TYPE A1P
1 BEDROOM**

AREA 56 sqm | 603 sqft

UNITS #12-02

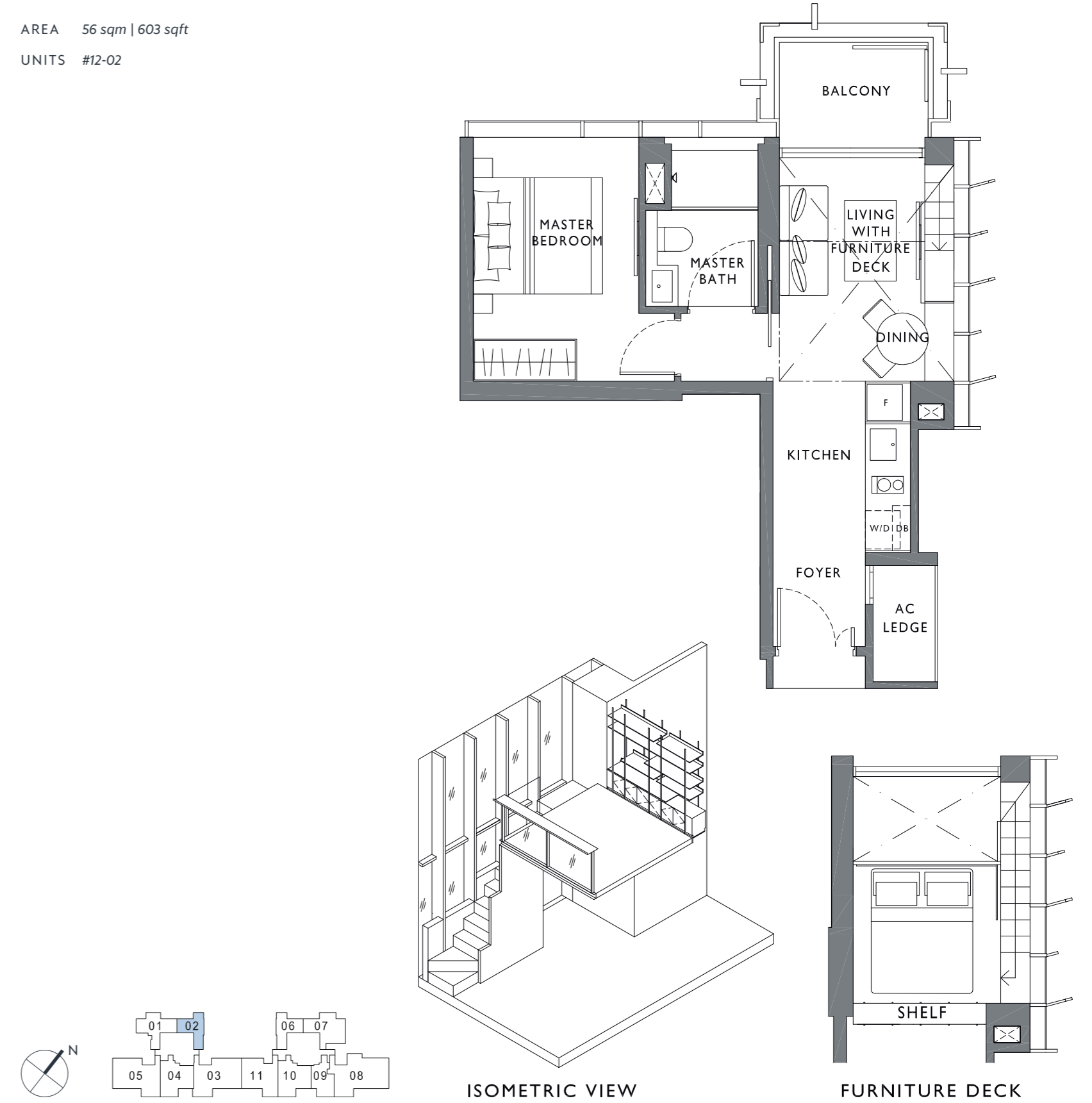

AREA INCLUDES A/C LEDGE, BALCONIES AND VOID WHERE APPLICABLE. AREAS ARE ESTIMATES ONLY AND ARE SUBJECT TO FINAL SURVEY. PLANS ARE NOT TO SCALE AND SUBJECT TO CHANGES AS MAY BE REQUIRED BY THE RELEVANT AUTHORITIES. THE BALCONIES SHALL NOT BE ENCLOSED UNLESS WITH APPROVED SCREEN. FOR AN ILLUSTRATION OF THE APPROVED BALCONY SCREEN, PLEASE REFER TO THE DIAGRAM ANNEXED HERETO AS 'ANNEXURE'.

AREA INCLUDES A/C LEDGE, BALCONIES AND VOID WHERE APPLICABLE. AREAS ARE ESTIMATES ONLY AND ARE SUBJECT TO FINAL SURVEY. PLANS ARE NOT TO SCALE AND SUBJECT TO CHANGES AS MAY BE REQUIRED BY THE RELEVANT AUTHORITIES. THE BALCONIES SHALL NOT BE ENCLOSED UNLESS WITH APPROVED SCREEN. FOR AN ILLUSTRATION OF THE APPROVED BALCONY SCREEN, PLEASE REFER TO THE DIAGRAM ANNEXED HERETO AS 'ANNEXURE'.

TYPE A1 (M)
1 BEDROOM

AREA 46 sqm | 495 sqft

UNITS Type A1M(a) #03-06, #06-06, #09-06
Type A1M(b) #04-06, #07-06, #10-06
Type A1M(c) #05-06, #08-06, #11-06

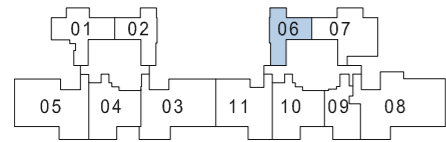
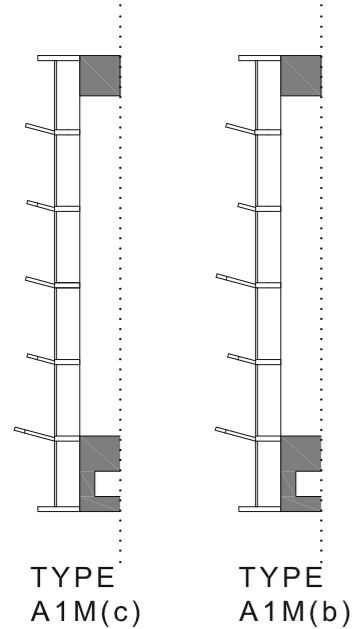
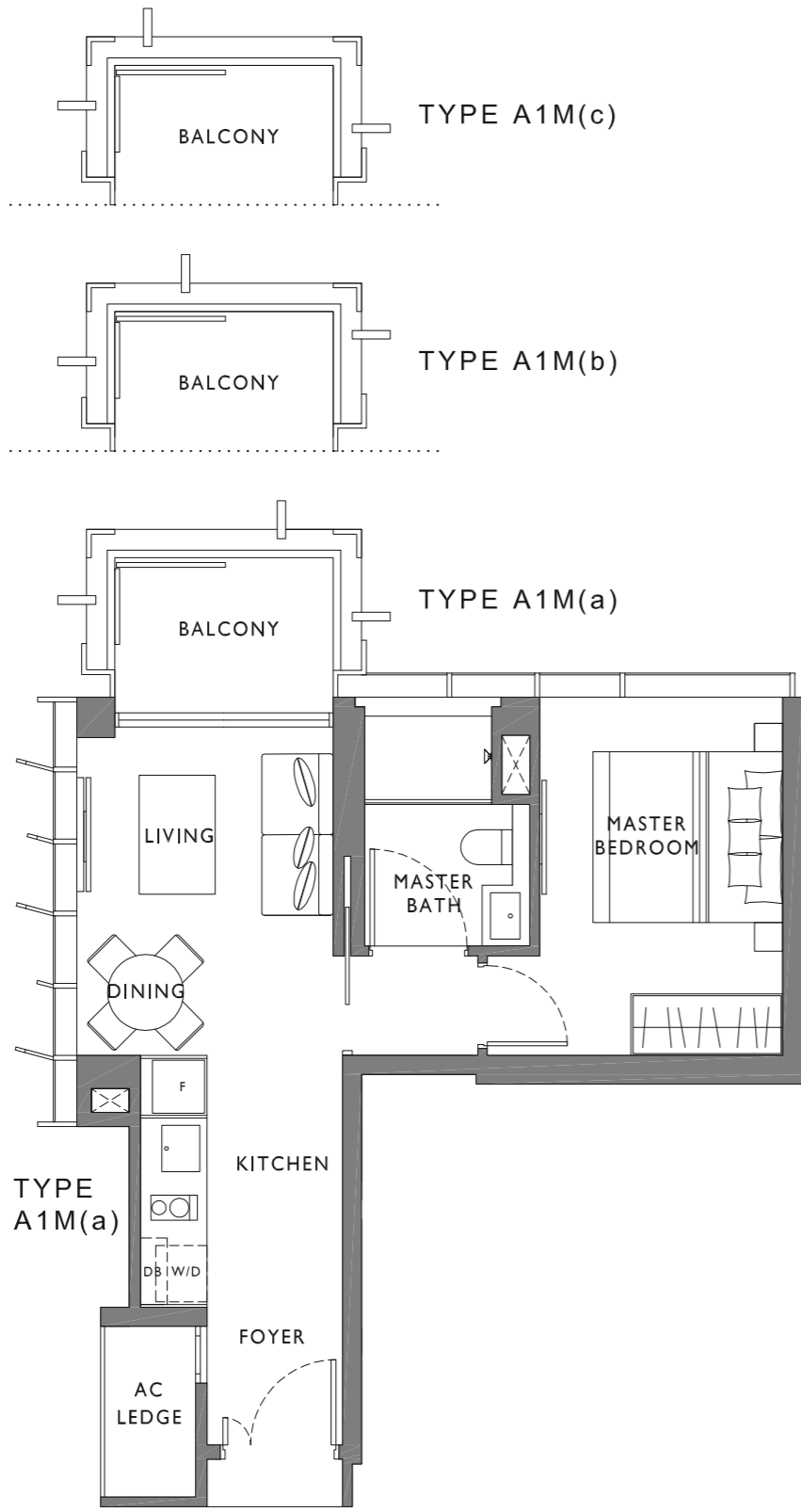

AREA INCLUDES A/C LEDGE, BALCONIES AND VOID WHERE APPLICABLE. AREAS ARE ESTIMATES ONLY AND ARE SUBJECT TO FINAL SURVEY. PLANS ARE NOT TO SCALE AND SUBJECT TO CHANGES AS MAY BE REQUIRED BY THE RELEVANT AUTHORITIES. THE BALCONIES SHALL NOT BE ENCLOSED UNLESS WITH APPROVED SCREEN. FOR AN ILLUSTRATION OF THE APPROVED BALCONY SCREEN, PLEASE REFER TO THE DIAGRAM ANNEXED HERETO AS 'ANNEXURE'.

TYPE A1P (M)
1 BEDROOM

AREA 56 sqm | 603 sqft

UNITS #12-06

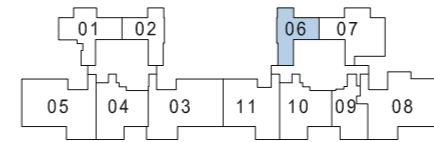
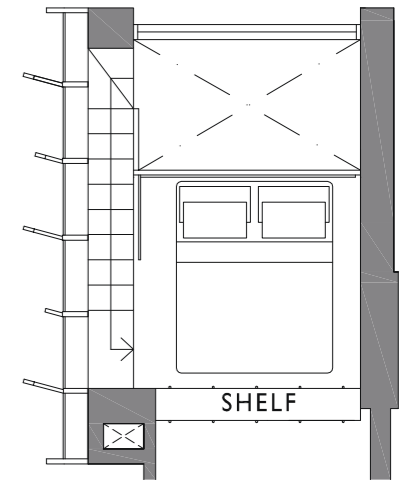
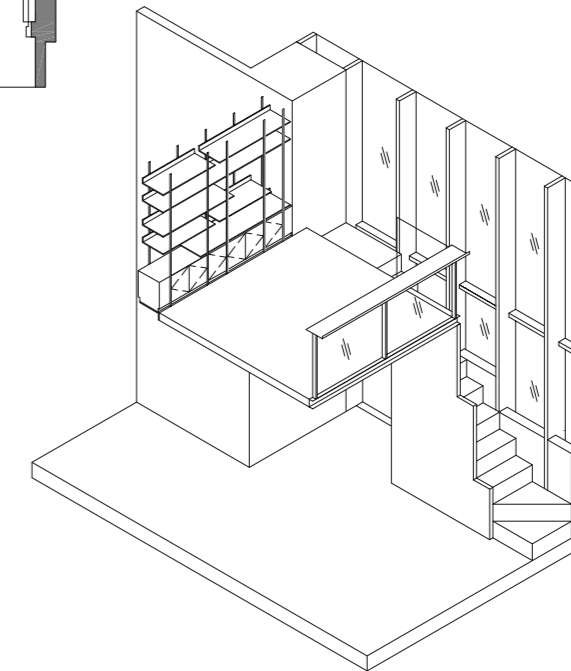
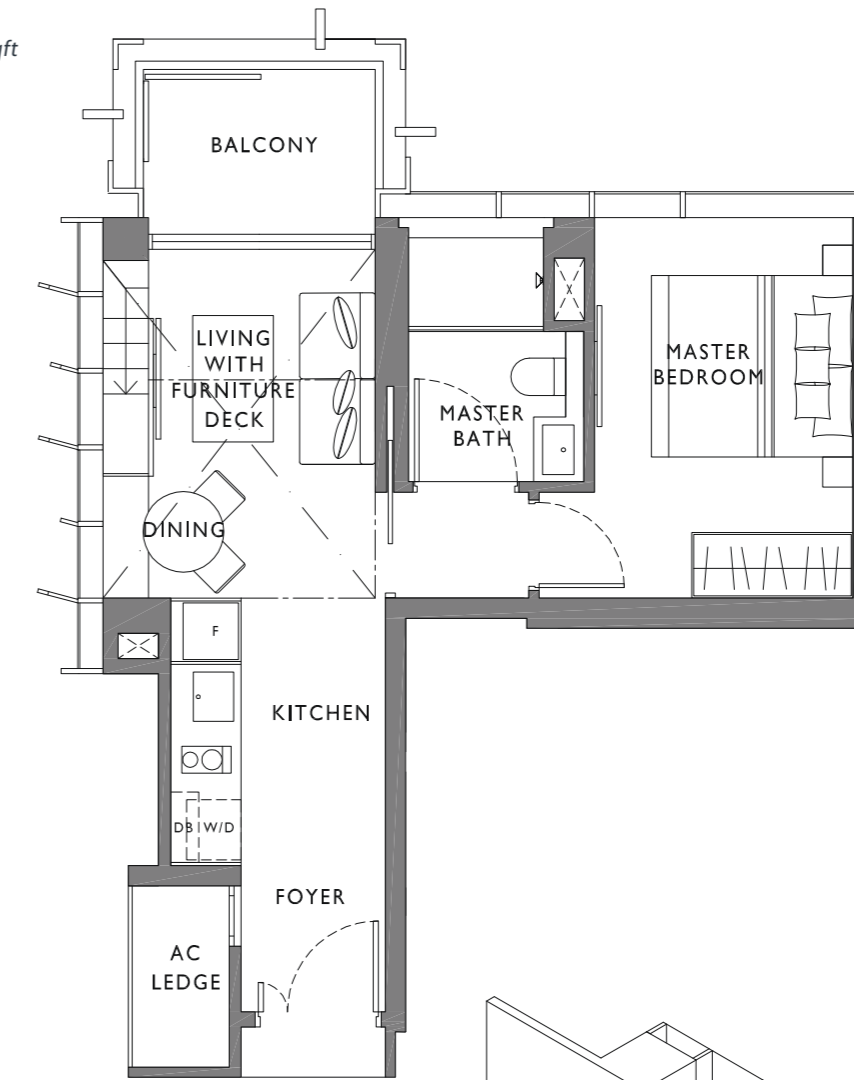

AREA INCLUDES A/C LEDGE, BALCONIES AND VOID WHERE APPLICABLE. AREAS ARE ESTIMATES ONLY AND ARE SUBJECT TO FINAL SURVEY. PLANS ARE NOT TO SCALE AND SUBJECT TO CHANGES AS MAY BE REQUIRED BY THE RELEVANT AUTHORITIES. THE BALCONIES SHALL NOT BE ENCLOSED UNLESS WITH APPROVED SCREEN. FOR AN ILLUSTRATION OF THE APPROVED BALCONY SCREEN, PLEASE REFER TO THE DIAGRAM ANNEXED HERETO AS 'ANNEXURE'.

**TYPE A2
1 BEDROOM**

AREA 51 sqm | 549 sqft

UNITS Type A2(a) #03-09, #06-09, #09-09
 Type A2(b) #04-09, #07-09, #10-09
 Type A2(c) #02-09, #05-09, #08-09, #11-09

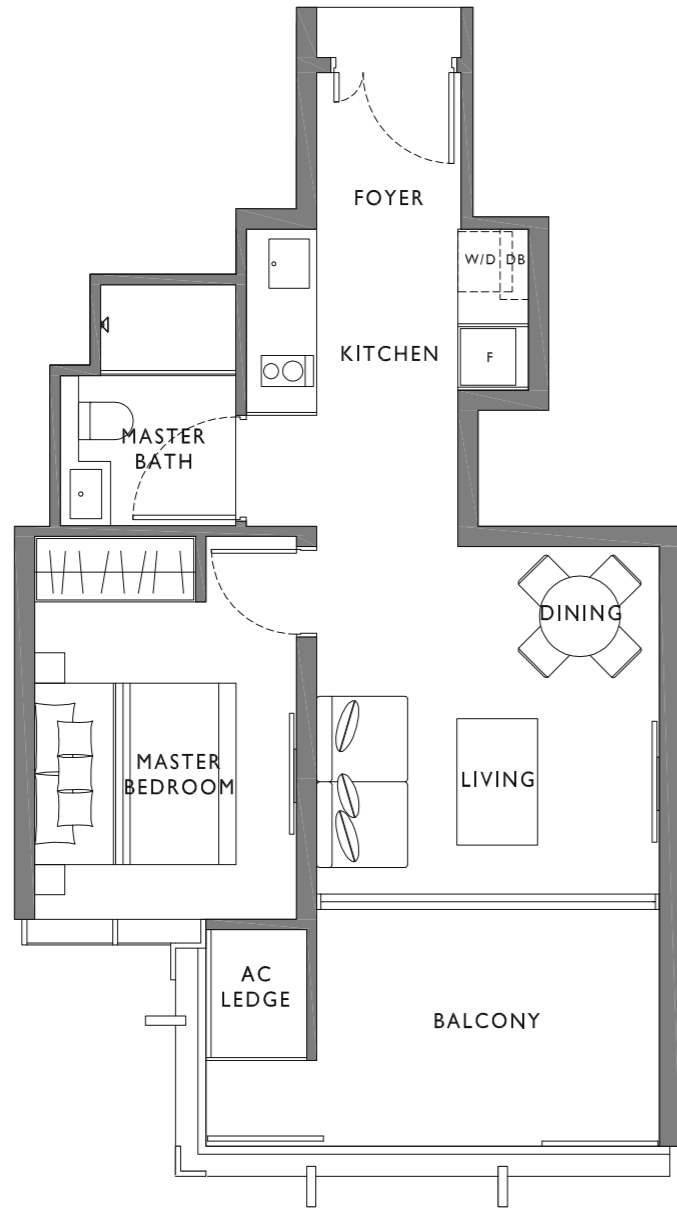

TYPE A2(a)

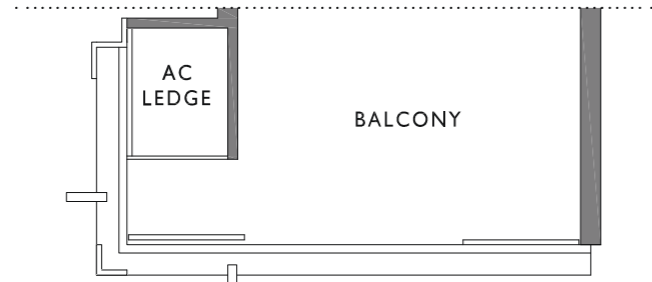

TYPE A2(b)

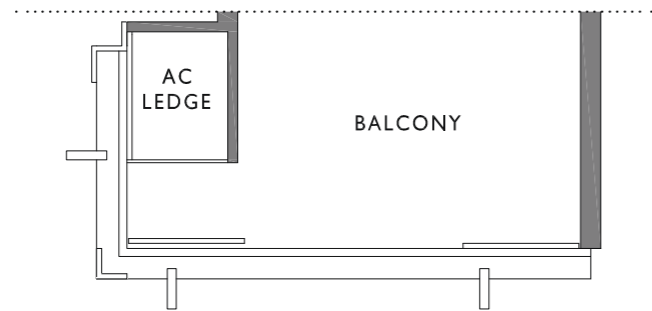

TYPE A2(c)

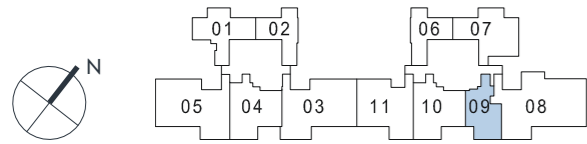

AREA INCLUDES A/C LEDGE, BALCONIES AND VOID WHERE APPLICABLE. AREAS ARE ESTIMATES ONLY AND ARE SUBJECT TO FINAL SURVEY. PLANS ARE NOT TO SCALE AND SUBJECT TO CHANGES AS MAY BE REQUIRED BY THE RELEVANT AUTHORITIES. THE BALCONIES SHALL NOT BE ENCLOSED UNLESS WITH APPROVED SCREEN. FOR AN ILLUSTRATION OF THE APPROVED BALCONY SCREEN, PLEASE REFER TO THE DIAGRAM ANNEXED HERETO AS 'ANNEXURE'.

**TYPE A2P
1 BEDROOM**

AREA 64 sqm | 689 sqft

UNITS #12-09

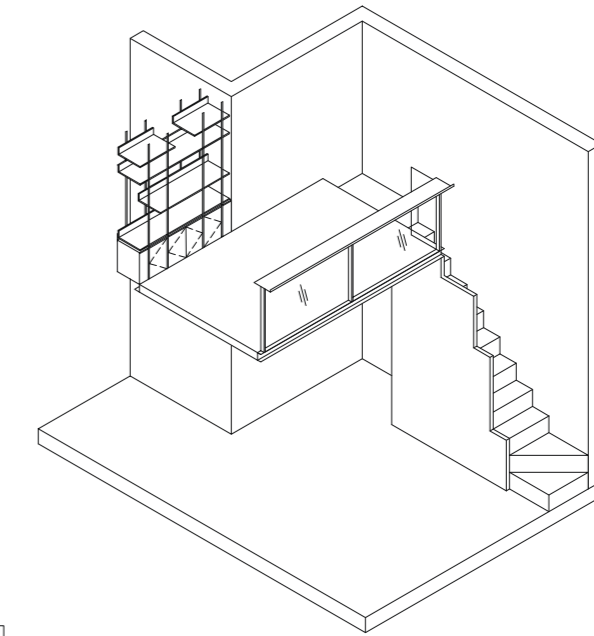
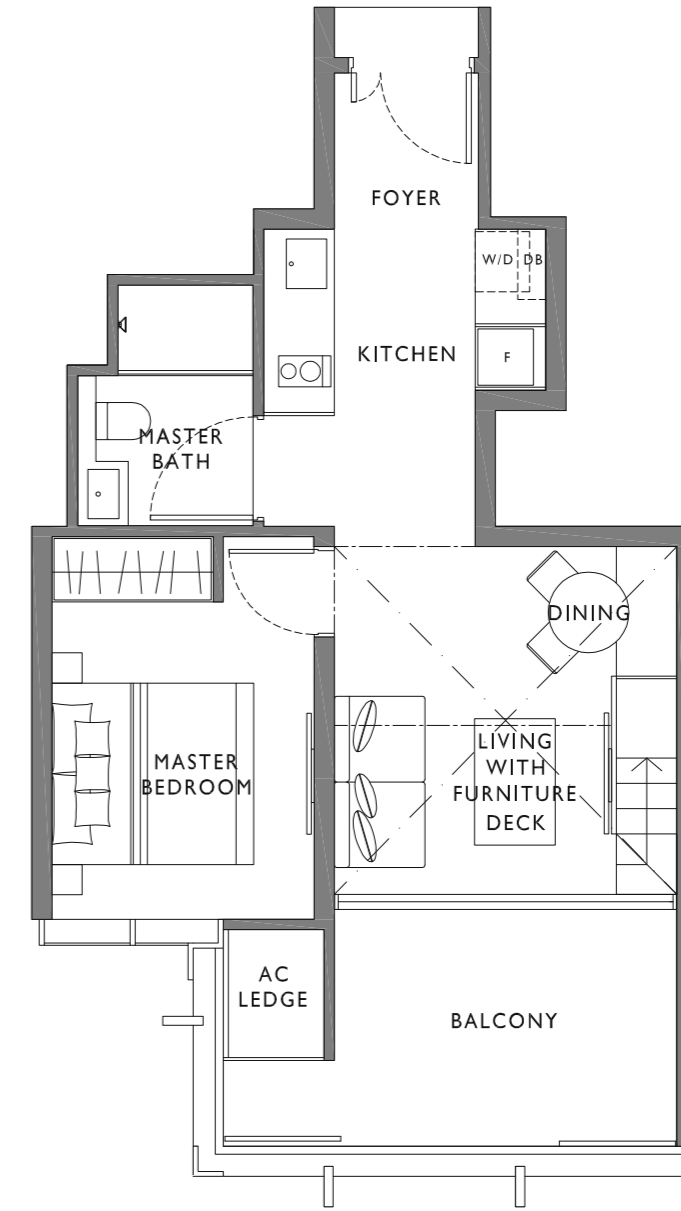

ISOMETRIC VIEW

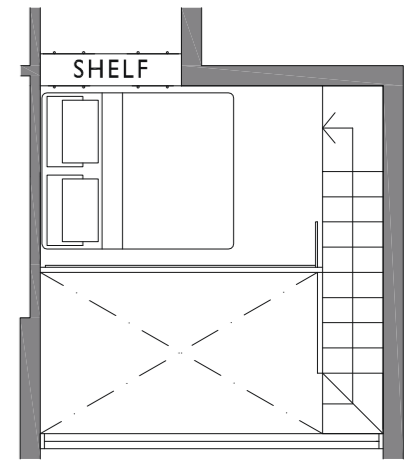

FURNITURE DECK

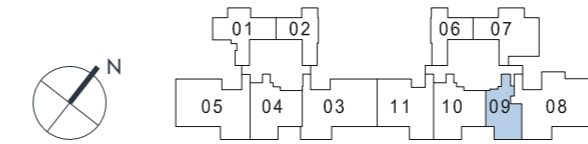

AREA INCLUDES A/C LEDGE, BALCONIES AND VOID WHERE APPLICABLE. AREAS ARE ESTIMATES ONLY AND ARE SUBJECT TO FINAL SURVEY. PLANS ARE NOT TO SCALE AND SUBJECT TO CHANGES AS MAY BE REQUIRED BY THE RELEVANT AUTHORITIES. THE BALCONIES SHALL NOT BE ENCLOSED UNLESS WITH APPROVED SCREEN. FOR AN ILLUSTRATION OF THE APPROVED BALCONY SCREEN, PLEASE REFER TO THE DIAGRAM ANNEXED HERETO AS 'ANNEXURE'.

**TYPE B1
2 BEDROOM**

AREA 63 sqm | 678 sqft

UNITS Type B1(a) #03-01, #06-01, #09-01
 Type B1(b) #04-01, #07-01, #10-01
 Type B1(c) #05-01, #08-01, #11-01

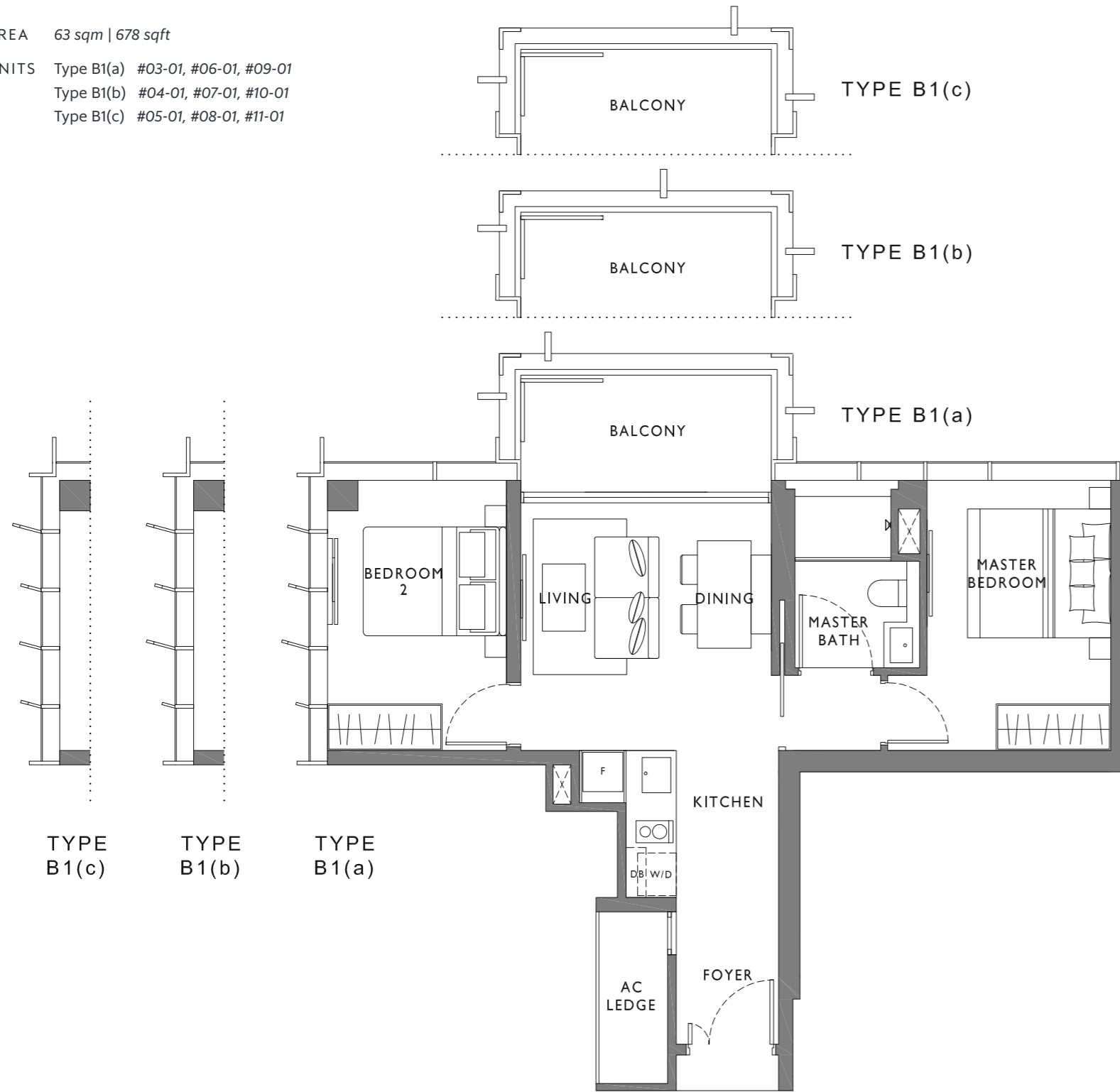

TYPE B1(c) TYPE B1(b) TYPE B1(a)

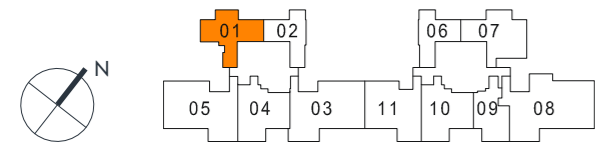

AREA INCLUDES A/C LEDGE, BALCONIES AND VOID WHERE APPLICABLE. AREAS ARE ESTIMATES ONLY AND ARE SUBJECT TO FINAL SURVEY. PLANS ARE NOT TO SCALE AND SUBJECT TO CHANGES AS MAY BE REQUIRED BY THE RELEVANT AUTHORITIES. THE BALCONIES SHALL NOT BE ENCLOSED UNLESS WITH APPROVED SCREEN. FOR AN ILLUSTRATION OF THE APPROVED BALCONY SCREEN, PLEASE REFER TO THE DIAGRAM ANNEXED HERETO AS 'ANNEXURE'.

**TYPE B1P
2 BEDROOM**

AREA 76 sqm | 818 sqft

UNITS #12-01

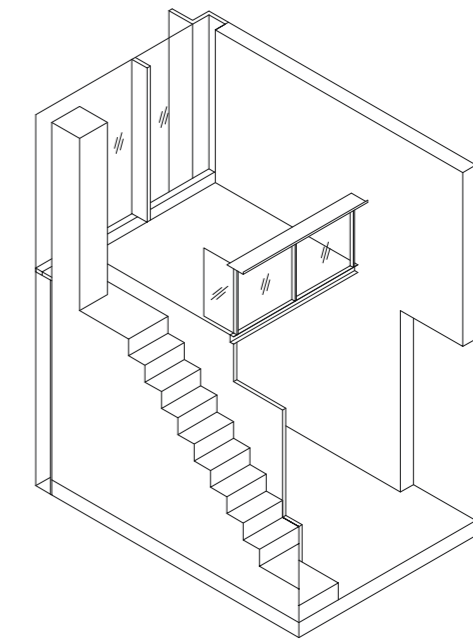
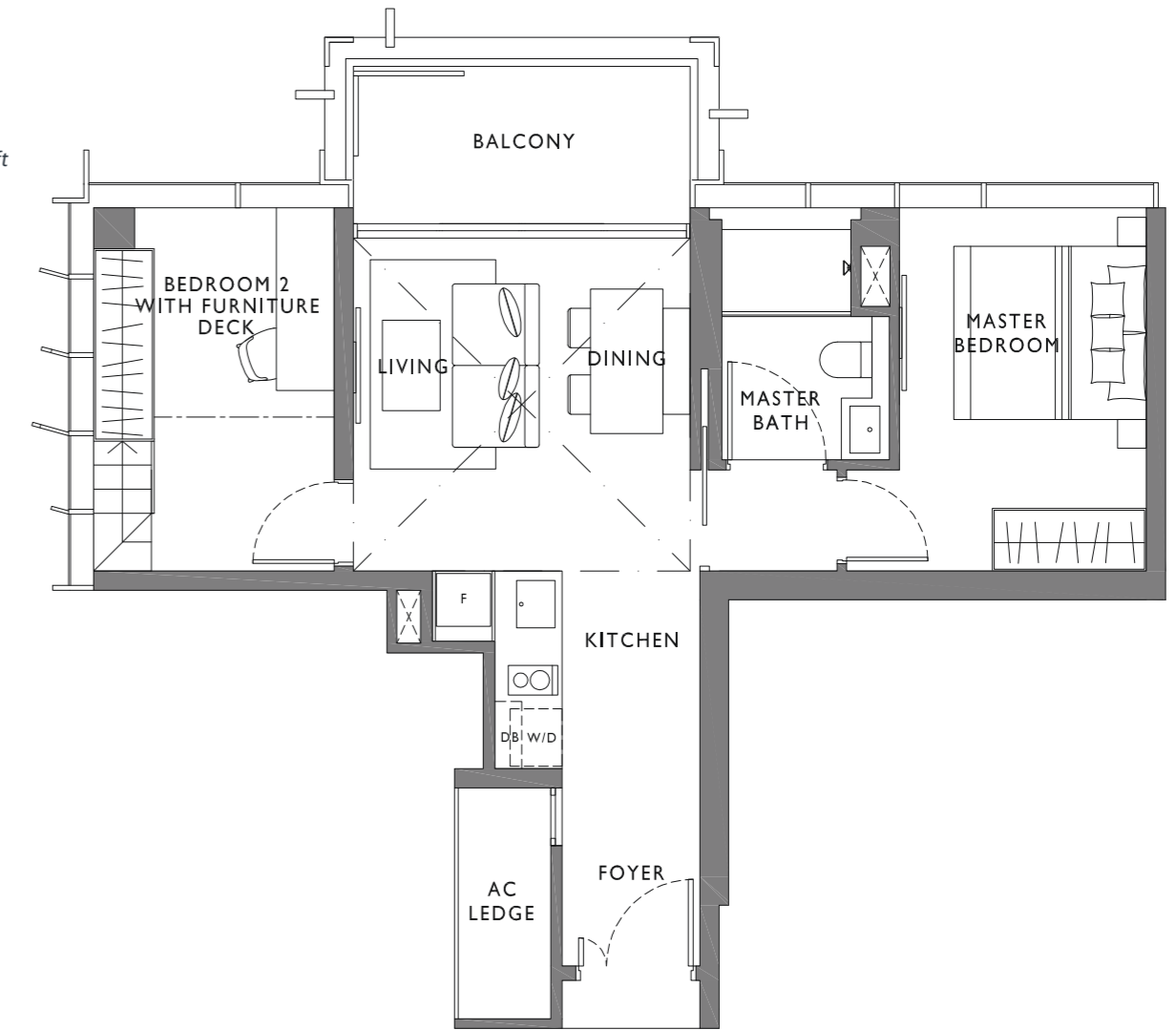

ISOMETRIC VIEW

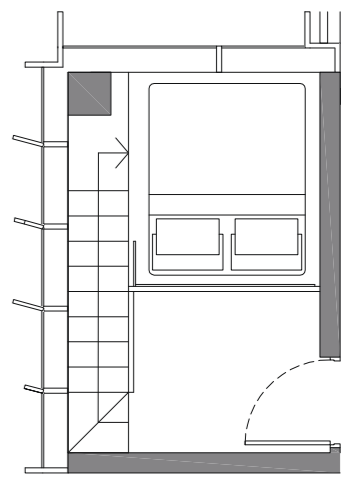

FURNITURE DECK

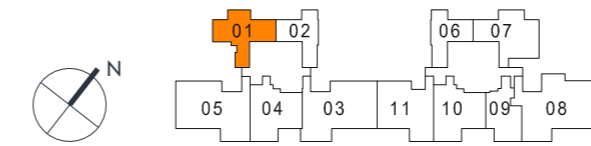

AREA INCLUDES A/C LEDGE, BALCONIES AND VOID WHERE APPLICABLE. AREAS ARE ESTIMATES ONLY AND ARE SUBJECT TO FINAL SURVEY. PLANS ARE NOT TO SCALE AND SUBJECT TO CHANGES AS MAY BE REQUIRED BY THE RELEVANT AUTHORITIES. THE BALCONIES SHALL NOT BE ENCLOSED UNLESS WITH APPROVED SCREEN. FOR AN ILLUSTRATION OF THE APPROVED BALCONY SCREEN, PLEASE REFER TO THE DIAGRAM ANNEXED HERETO AS 'ANNEXURE'.

**TYPE B2
2 BEDROOM**

AREA 72 sqm | 775 sqft

UNITS Type B2(a) #03-07, #06-07, #09-07
 Type B2(b) #04-07, #07-07, #10-07
 Type B2(c) #05-07, #08-07, #11-07

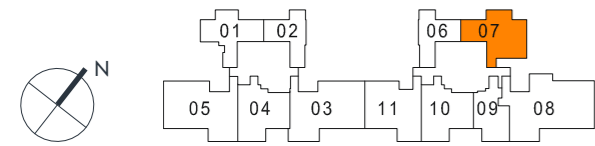
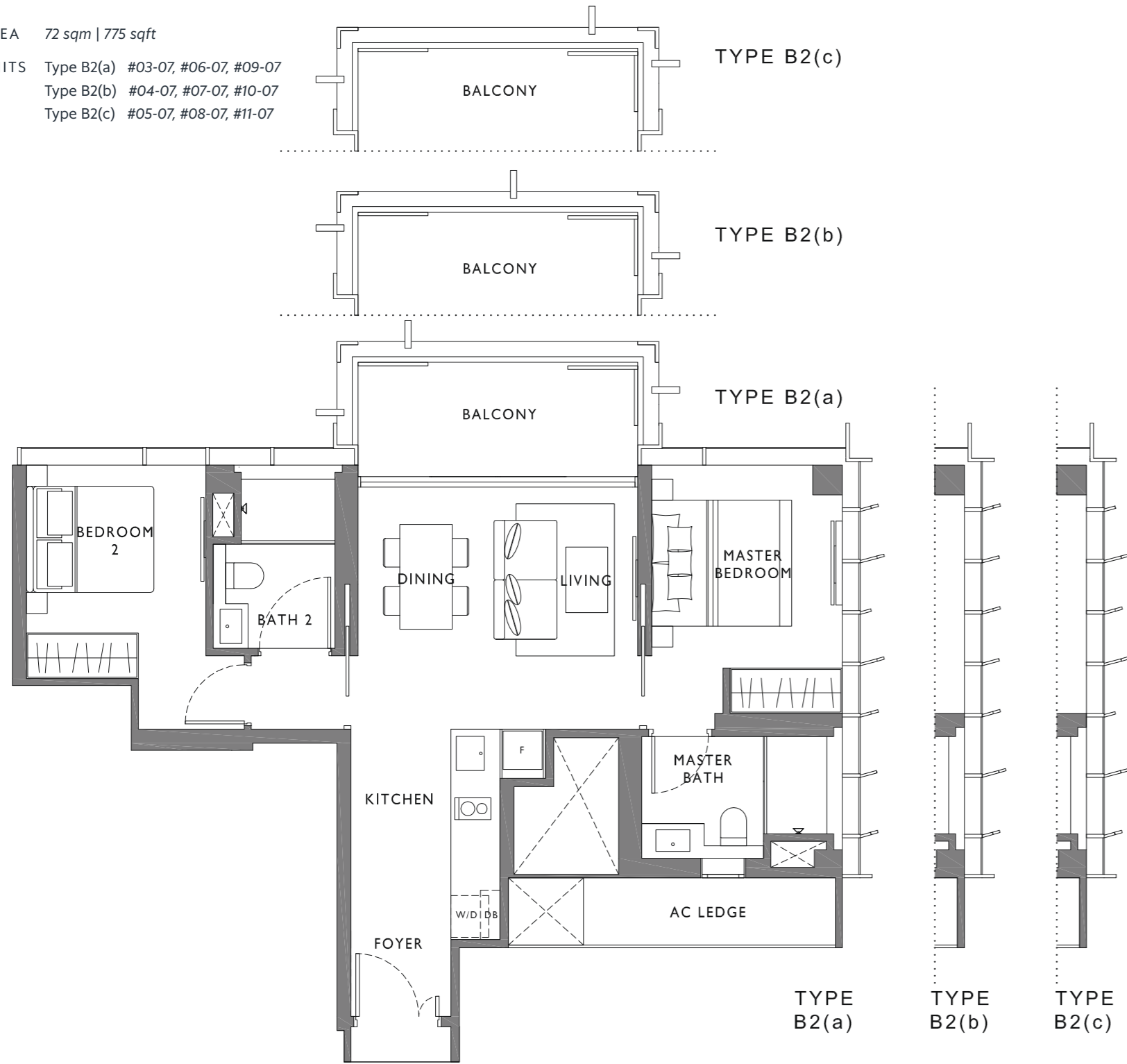

AREA INCLUDES A/C LEDGE, BALCONIES AND VOID WHERE APPLICABLE. AREAS ARE ESTIMATES ONLY AND ARE SUBJECT TO FINAL SURVEY. PLANS ARE NOT TO SCALE AND SUBJECT TO CHANGES AS MAY BE REQUIRED BY THE RELEVANT AUTHORITIES. THE BALCONIES SHALL NOT BE ENCLOSED UNLESS WITH APPROVED SCREEN. FOR AN ILLUSTRATION OF THE APPROVED BALCONY SCREEN, PLEASE REFER TO THE DIAGRAM ANNEXED HERETO AS 'ANNEXURE'.

**TYPE B2P
2 BEDROOM**

AREA 87 sqm | 936 sqft

UNITS #12-07

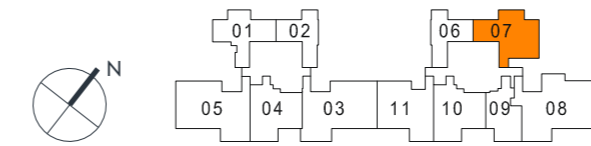
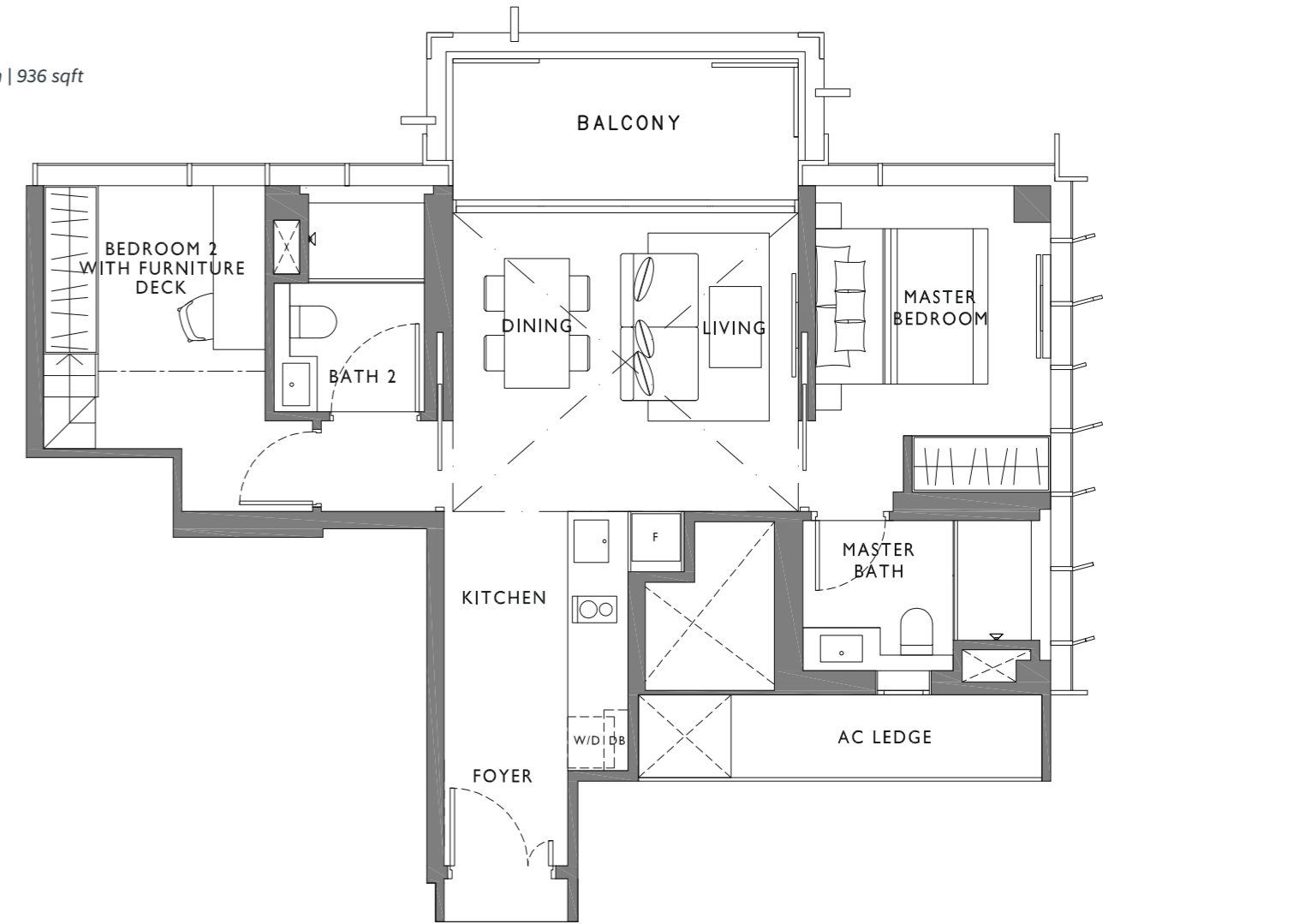

AREA INCLUDES A/C LEDGE, BALCONIES AND VOID WHERE APPLICABLE. AREAS ARE ESTIMATES ONLY AND ARE SUBJECT TO FINAL SURVEY. PLANS ARE NOT TO SCALE AND SUBJECT TO CHANGES AS MAY BE REQUIRED BY THE RELEVANT AUTHORITIES. THE BALCONIES SHALL NOT BE ENCLOSED UNLESS WITH APPROVED SCREEN. FOR AN ILLUSTRATION OF THE APPROVED BALCONY SCREEN, PLEASE REFER TO THE DIAGRAM ANNEXED HERETO AS 'ANNEXURE'.

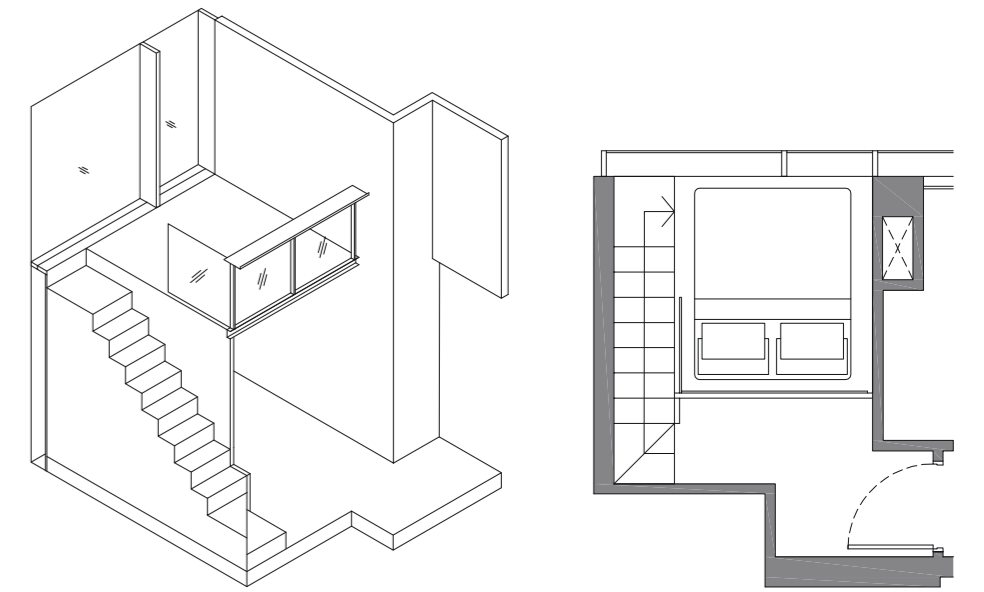

ISOMETRIC VIEW

FURNITURE DECK

**TYPE B3
2 BEDROOM**

AREA 76 sqm | 818 sqft

- UNITS Type B3(a) #03-04, #06-04, #09-04
 #03-10, #06-10, #09-10
 Type B3(b) #04-04, #07-04, #10-04
 #04-10, #07-10, #10-10
 Type B3(c) #02-04, #05-04, #08-04, #11-04
 #02-10, #05-10, #08-10, #11-10

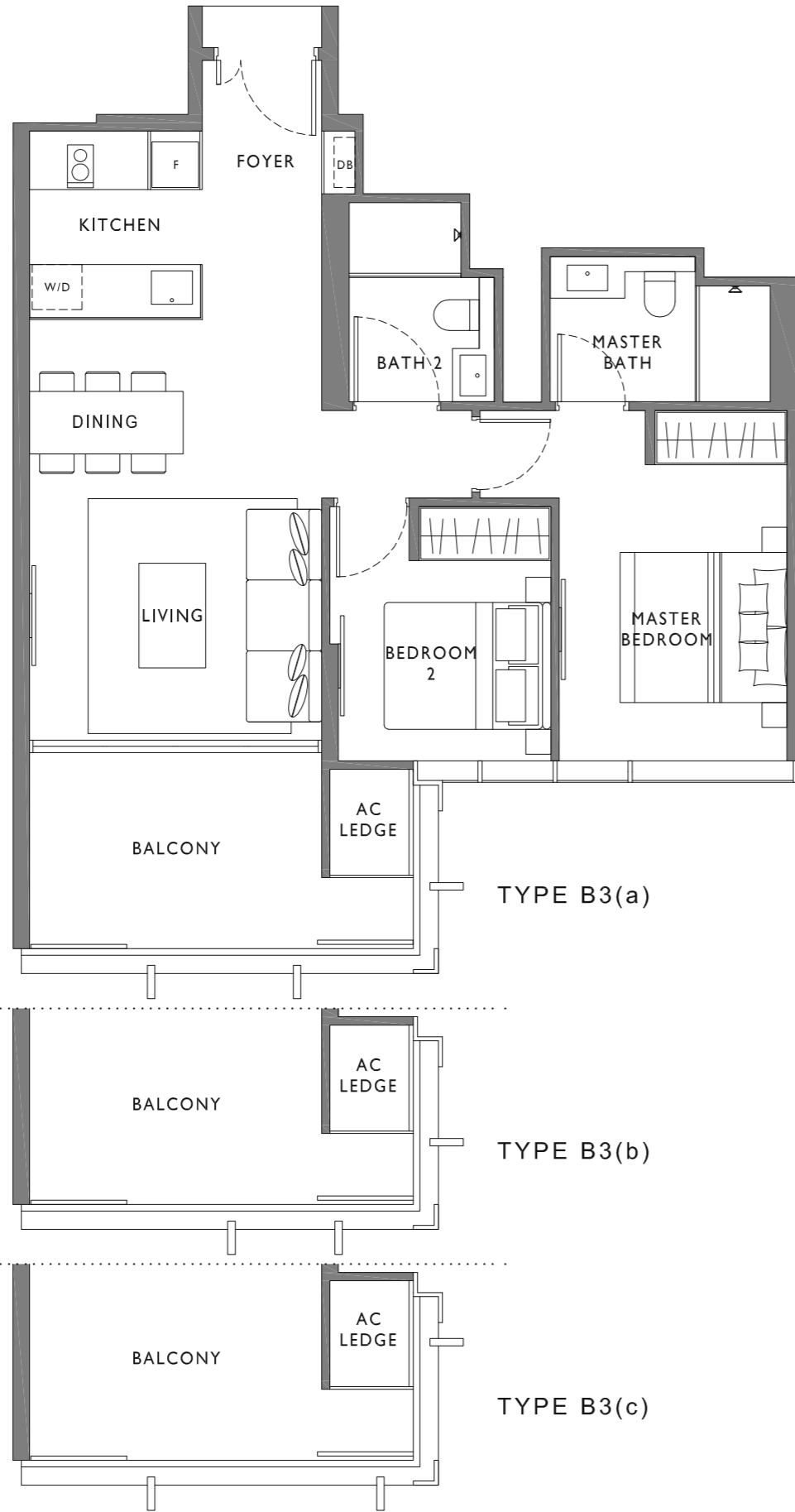

**TYPE B3P
2 BEDROOM**

AREA 91 sqm | 980 sqft

- UNITS #12-04, #12-10

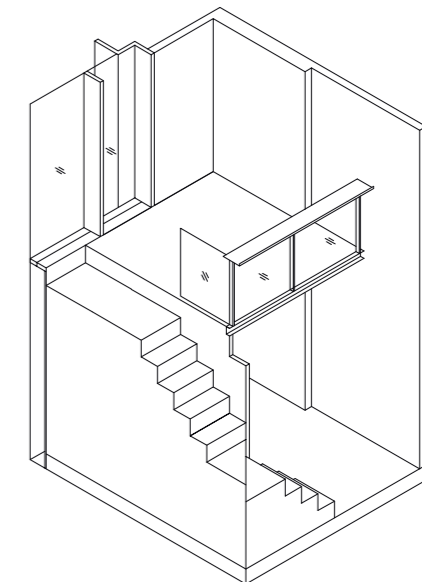
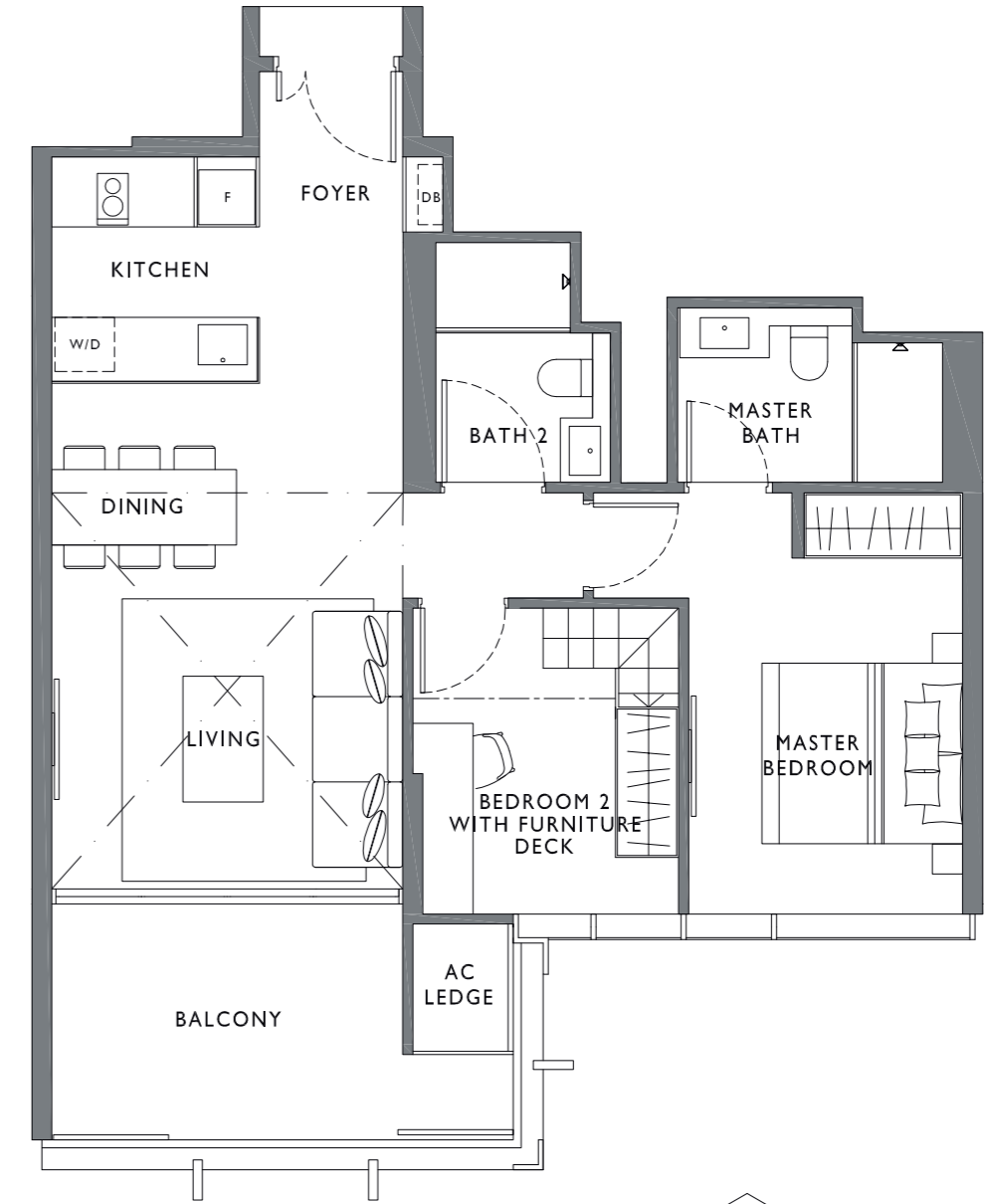

ISOMETRIC VIEW

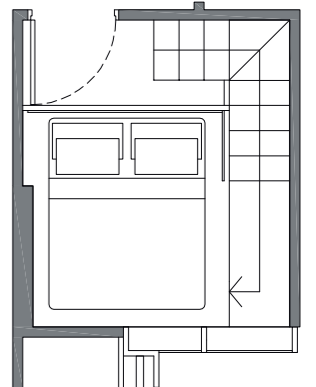

FURNITURE DECK

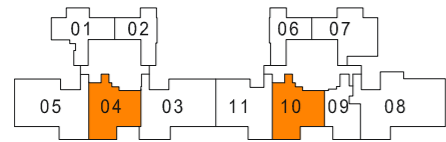

AREA INCLUDES A/C LEDGE, BALCONIES AND VOID WHERE APPLICABLE. AREAS ARE ESTIMATES ONLY AND ARE SUBJECT TO FINAL SURVEY. PLANS ARE NOT TO SCALE AND SUBJECT TO CHANGES AS MAY BE REQUIRED BY THE RELEVANT AUTHORITIES. THE BALCONIES SHALL NOT BE ENCLOSED UNLESS WITH APPROVED SCREEN. FOR AN ILLUSTRATION OF THE APPROVED BALCONY SCREEN, PLEASE REFER TO THE DIAGRAM ANNEXED HERETO AS 'ANNEXURE'.

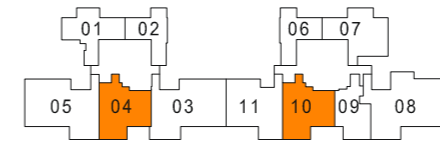

AREA INCLUDES A/C LEDGE, BALCONIES AND VOID WHERE APPLICABLE. AREAS ARE ESTIMATES ONLY AND ARE SUBJECT TO FINAL SURVEY. PLANS ARE NOT TO SCALE AND SUBJECT TO CHANGES AS MAY BE REQUIRED BY THE RELEVANT AUTHORITIES. THE BALCONIES SHALL NOT BE ENCLOSED UNLESS WITH APPROVED SCREEN. FOR AN ILLUSTRATION OF THE APPROVED BALCONY SCREEN, PLEASE REFER TO THE DIAGRAM ANNEXED HERETO AS 'ANNEXURE'.

TYPE B4
2 BEDROOM + GUEST

AREA 88 sqm | 947 sqft
 UNITS Type B4(a) #03-11, #06-11, #09-11
 Type B4(b) #04-11, #07-11, #10-11
 Type B4(c) #02-11, #05-11, #08-11, #11-11

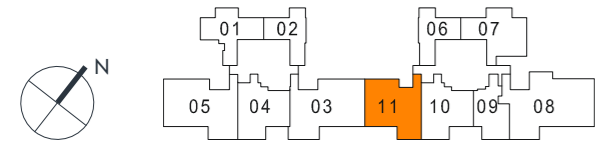
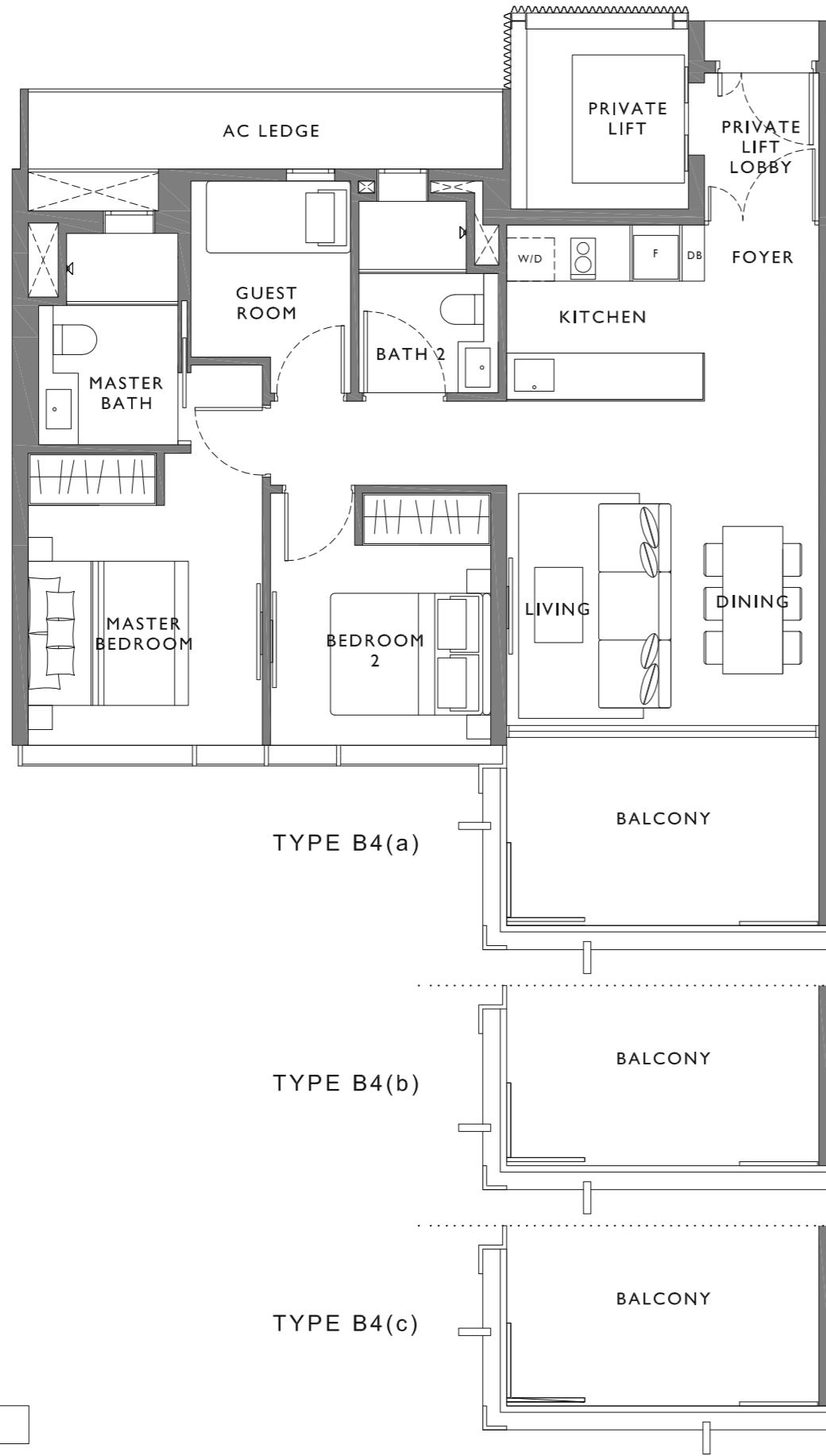

AREA INCLUDES A/C LEDGE, BALCONIES AND VOID WHERE APPLICABLE. AREAS ARE ESTIMATES ONLY AND ARE SUBJECT TO FINAL SURVEY. PLANS ARE NOT TO SCALE AND SUBJECT TO CHANGES AS MAY BE REQUIRED BY THE RELEVANT AUTHORITIES. THE BALCONIES SHALL NOT BE ENCLOSED UNLESS WITH APPROVED SCREEN. FOR AN ILLUSTRATION OF THE APPROVED BALCONY SCREEN, PLEASE REFER TO THE DIAGRAM ANNEXED HERETO AS 'ANNEXURE'.

TYPE B4P
2 BEDROOM + GUEST

AREA 105 sqm | 1130 sqft
 UNITS #12-11

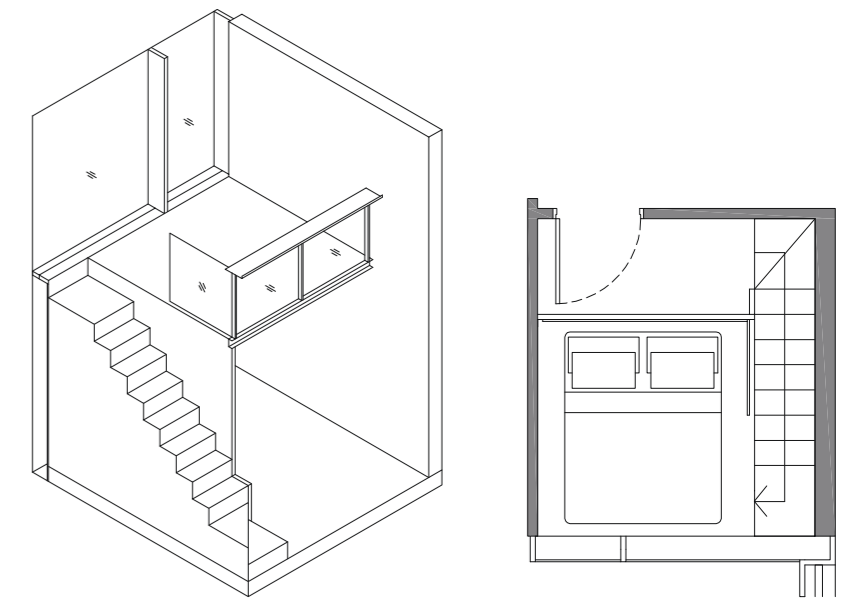
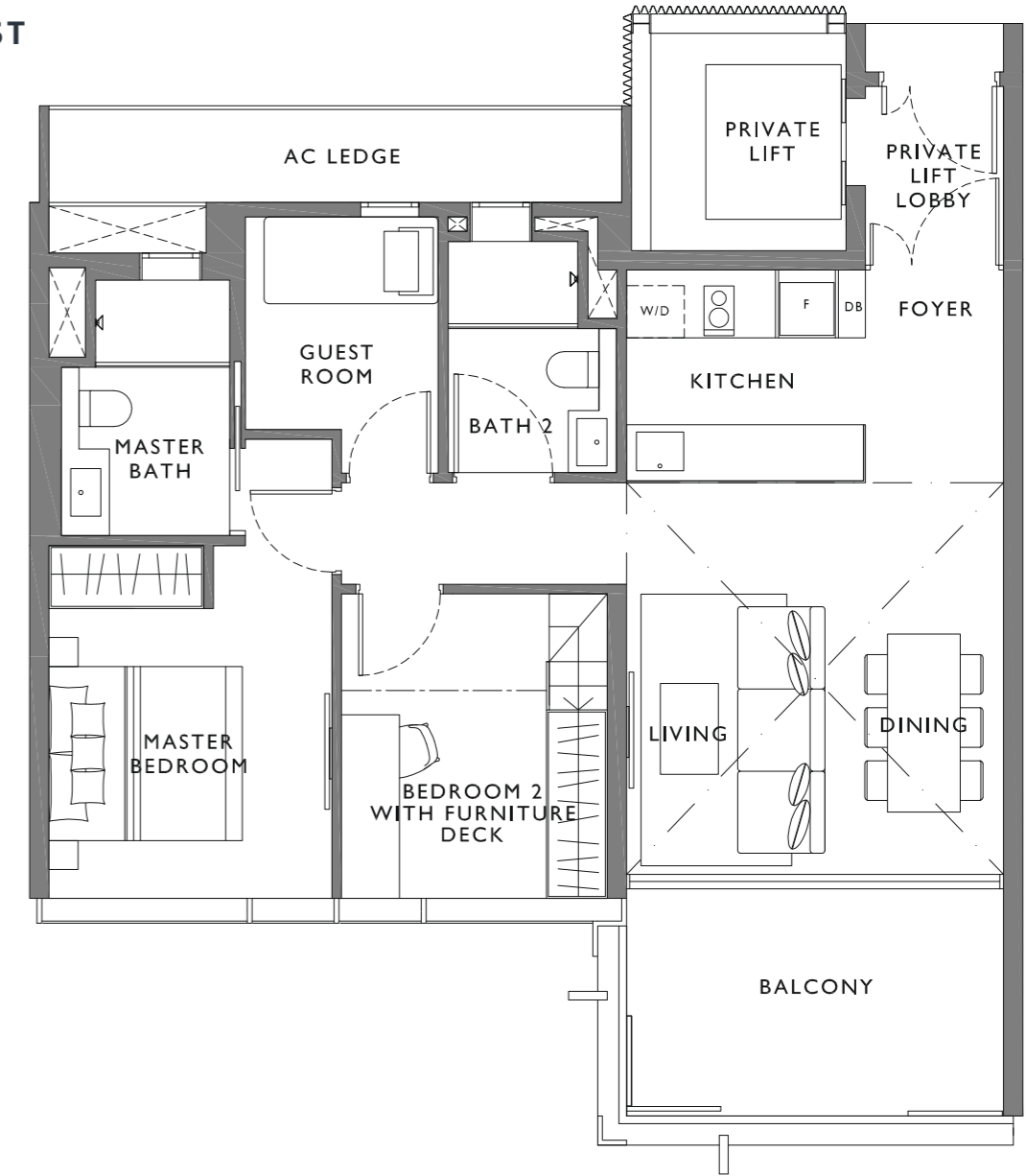

ISOMETRIC VIEW

FURNITURE DECK

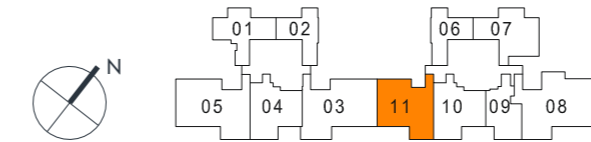

AREA INCLUDES A/C LEDGE, BALCONIES AND VOID WHERE APPLICABLE. AREAS ARE ESTIMATES ONLY AND ARE SUBJECT TO FINAL SURVEY. PLANS ARE NOT TO SCALE AND SUBJECT TO CHANGES AS MAY BE REQUIRED BY THE RELEVANT AUTHORITIES. THE BALCONIES SHALL NOT BE ENCLOSED UNLESS WITH APPROVED SCREEN. FOR AN ILLUSTRATION OF THE APPROVED BALCONY SCREEN, PLEASE REFER TO THE DIAGRAM ANNEXED HERETO AS 'ANNEXURE'.

**TYPE C1
3 BEDROOM**

AREA 116 sqm | 1249 sqft

UNITS Type C1(a) #03-03, #06-03, #09-03
 Type C1(b) #04-03, #07-03, #10-03
 Type C1(c) #02-03, #05-03, #08-03, #11-03

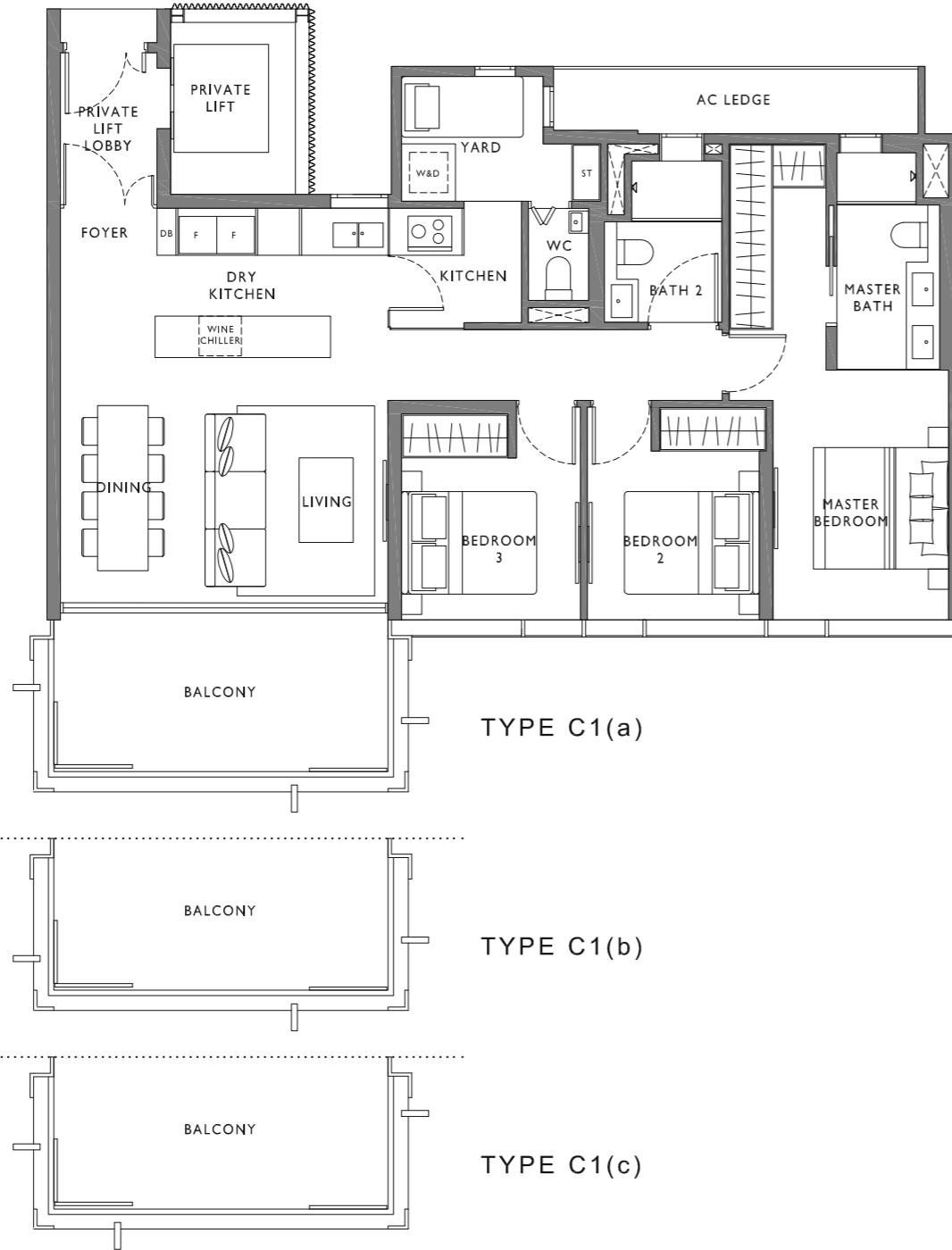

**TYPE C1P
3 BEDROOM**

AREA 137 sqm | 1475 sqft

UNITS #12-03

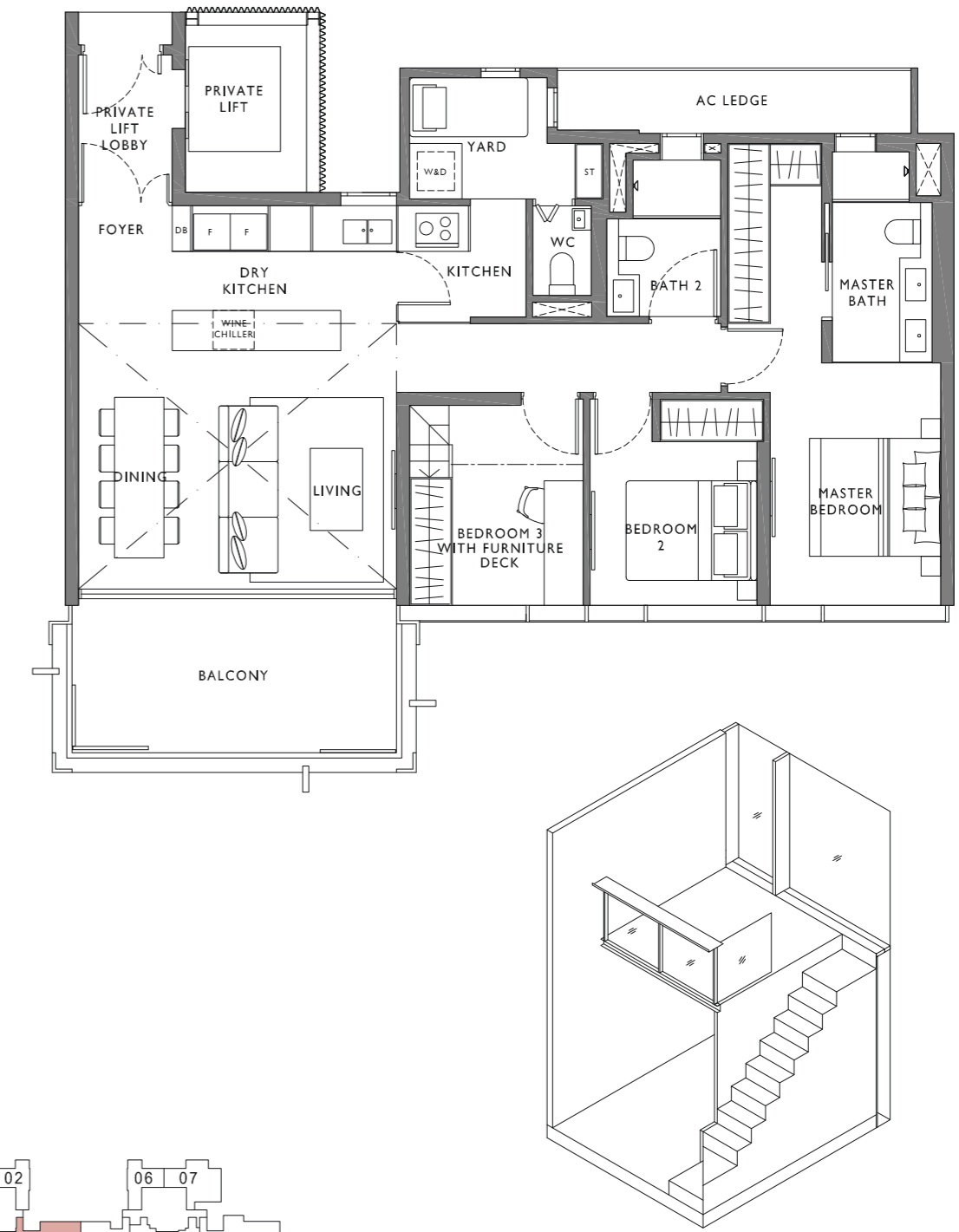

ISOMETRIC VIEW

FURNITURE DECK

AREA INCLUDES A/C LEDGE, BALCONIES AND VOID WHERE APPLICABLE. AREAS ARE ESTIMATES ONLY AND ARE SUBJECT TO FINAL SURVEY. PLANS ARE NOT TO SCALE AND SUBJECT TO CHANGES AS MAY BE REQUIRED BY THE RELEVANT AUTHORITIES. THE BALCONIES SHALL NOT BE ENCLOSED UNLESS WITH APPROVED SCREEN. FOR AN ILLUSTRATION OF THE APPROVED BALCONY SCREEN, PLEASE REFER TO THE DIAGRAM ANNEXED HERETO AS "ANNEXURE".

AREA INCLUDES A/C LEDGE, BALCONIES AND VOID WHERE APPLICABLE. AREAS ARE ESTIMATES ONLY AND ARE SUBJECT TO FINAL SURVEY. PLANS ARE NOT TO SCALE AND SUBJECT TO CHANGES AS MAY BE REQUIRED BY THE RELEVANT AUTHORITIES. THE BALCONIES SHALL NOT BE ENCLOSED UNLESS WITH APPROVED SCREEN. FOR AN ILLUSTRATION OF THE APPROVED BALCONY SCREEN, PLEASE REFER TO THE DIAGRAM ANNEXED HERETO AS "ANNEXURE".

**TYPE C2
3 BEDROOM**

AREA 116 sqm | 1249 sqft

UNITS Type C2(a) #03-05, #06-05, #09-05
 Type C2(b) #04-05, #07-05, #10-05
 Type C2(c) #02-05, #05-05, #08-05, #11-05

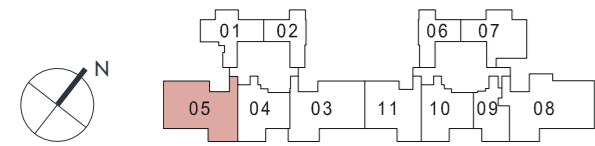

AREA INCLUDES A/C LEDGE, BALCONIES AND VOID WHERE APPLICABLE. AREAS ARE ESTIMATES ONLY AND ARE SUBJECT TO FINAL SURVEY. PLANS ARE NOT TO SCALE AND SUBJECT TO CHANGES AS MAY BE REQUIRED BY THE RELEVANT AUTHORITIES. THE BALCONIES SHALL NOT BE ENCLOSED UNLESS WITH APPROVED SCREEN. FOR AN ILLUSTRATION OF THE APPROVED BALCONY SCREEN, PLEASE REFER TO THE DIAGRAM ANNEXED HERETO AS 'ANNEXURE'.

**TYPE C2P
3 BEDROOM**

AREA 137 sqm | 1475 sqft

UNITS #12-05

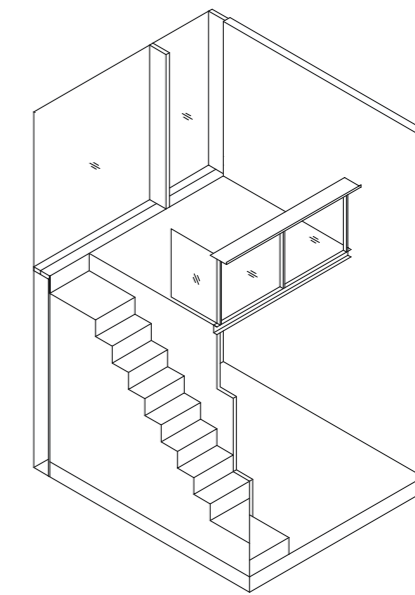
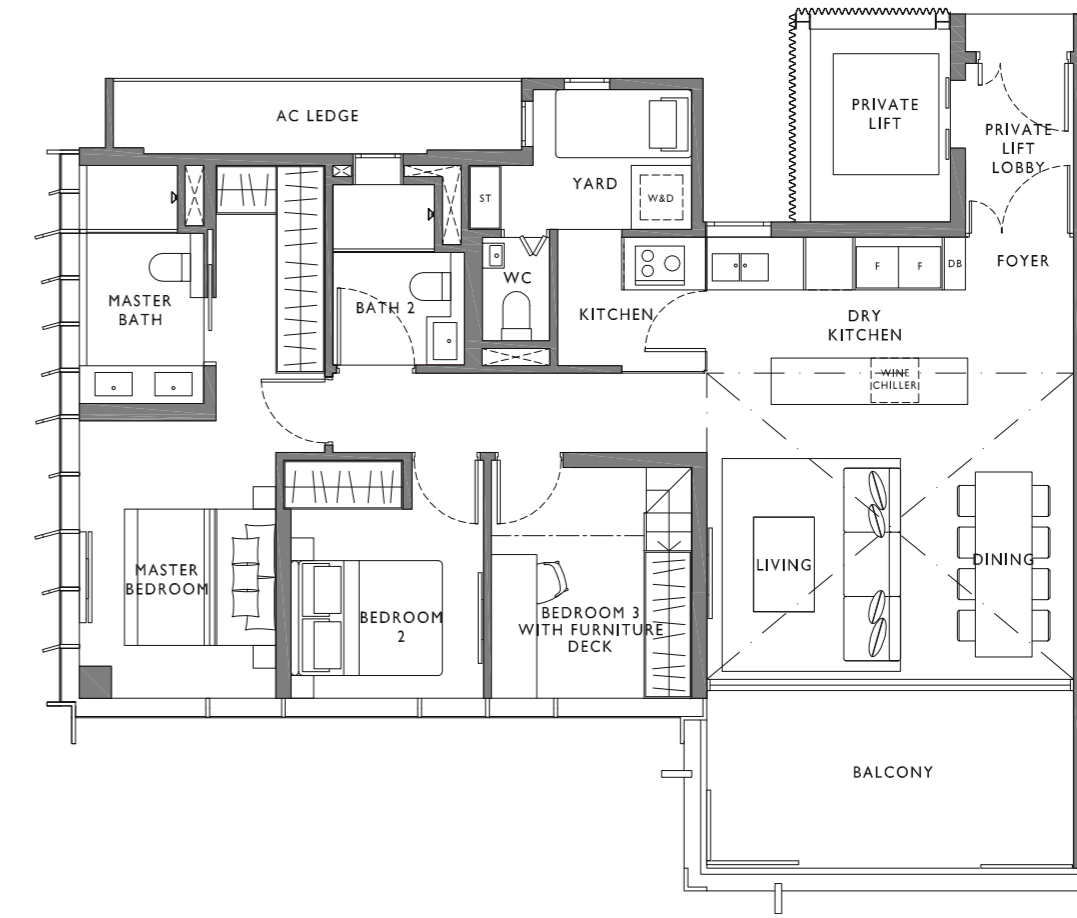

ISOMETRIC VIEW

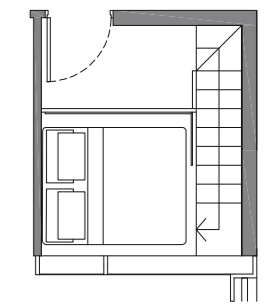

FURNITURE DECK

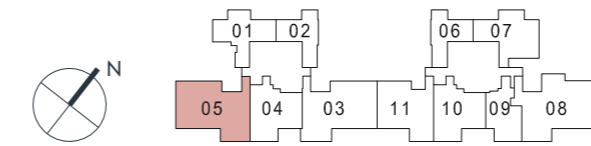

AREA INCLUDES A/C LEDGE, BALCONIES AND VOID WHERE APPLICABLE. AREAS ARE ESTIMATES ONLY AND ARE SUBJECT TO FINAL SURVEY. PLANS ARE NOT TO SCALE AND SUBJECT TO CHANGES AS MAY BE REQUIRED BY THE RELEVANT AUTHORITIES. THE BALCONIES SHALL NOT BE ENCLOSED UNLESS WITH APPROVED SCREEN. FOR AN ILLUSTRATION OF THE APPROVED BALCONY SCREEN, PLEASE REFER TO THE DIAGRAM ANNEXED HERETO AS 'ANNEXURE'.

**TYPE D
4 BEDROOM**

AREA 146 sqm | 1572 sqft

UNITS Type D(a) #03-08, #06-08, #09-08
 Type D(b) #04-08, #07-08, #10-08
 Type D(c) #02-08, #05-08, #08-08, #11-08

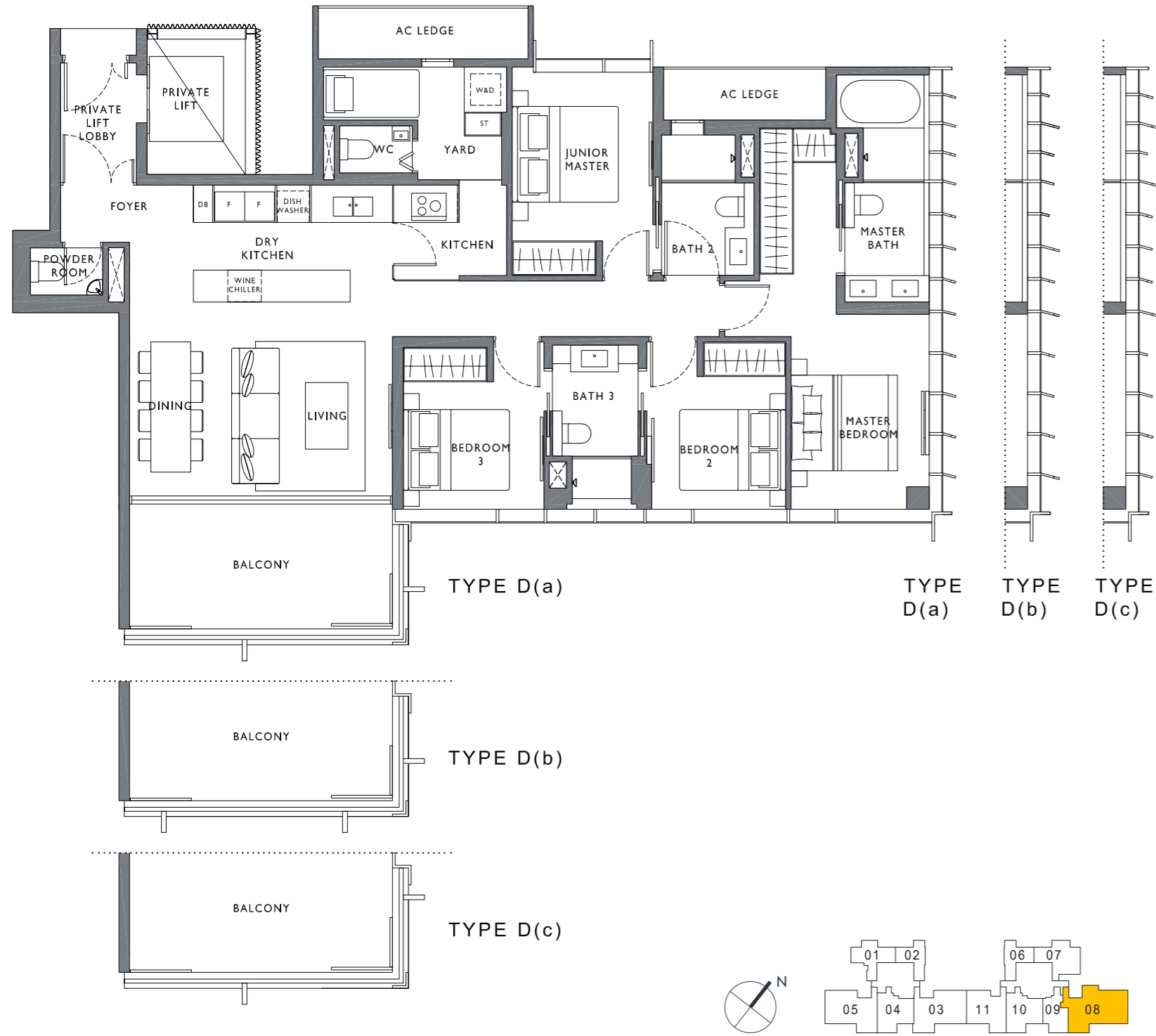

**TYPE DP
4 BEDROOM**

AREA 167 sqm | 1798 sqft

UNITS #12-08

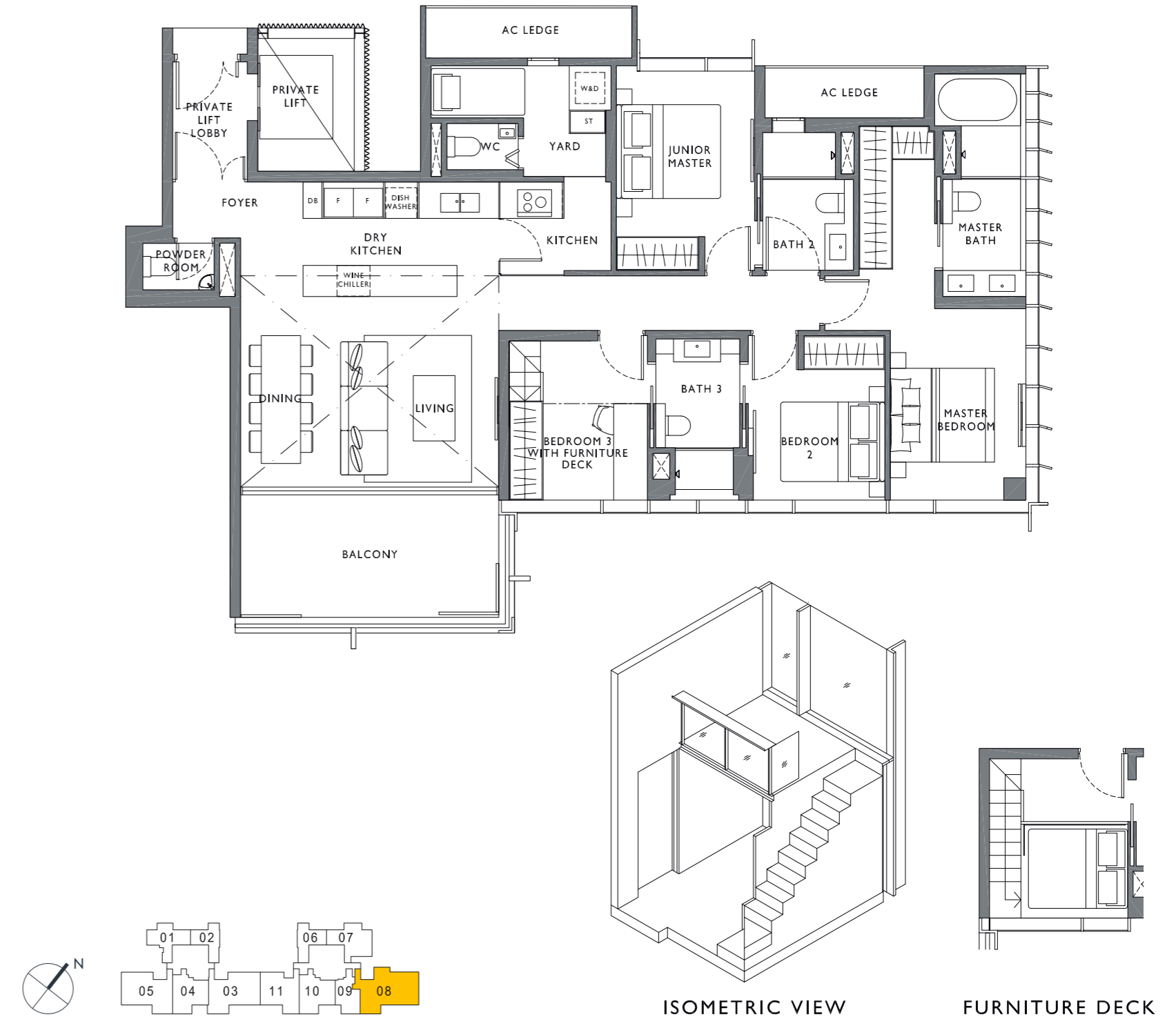

AREA INCLUDES A/C LEDGE, BALCONIES AND VOID WHERE APPLICABLE. AREAS ARE ESTIMATES ONLY AND ARE SUBJECT TO FINAL SURVEY. PLANS ARE NOT TO SCALE AND SUBJECT TO CHANGES AS MAY BE REQUIRED BY THE RELEVANT AUTHORITIES. THE BALCONIES SHALL NOT BE ENCLOSED UNLESS WITH APPROVED SCREEN. FOR AN ILLUSTRATION OF THE APPROVED BALCONY SCREEN, PLEASE REFER TO THE DIAGRAM ANNEXED HERETO AS "ANNEXURE".

AREA INCLUDES A/C LEDGE, BALCONIES AND VOID WHERE APPLICABLE. AREAS ARE ESTIMATES ONLY AND ARE SUBJECT TO FINAL SURVEY. PLANS ARE NOT TO SCALE AND SUBJECT TO CHANGES AS MAY BE REQUIRED BY THE RELEVANT AUTHORITIES. THE BALCONIES SHALL NOT BE ENCLOSED UNLESS WITH APPROVED SCREEN. FOR AN ILLUSTRATION OF THE APPROVED BALCONY SCREEN, PLEASE REFER TO THE DIAGRAM ANNEXED HERETO AS "ANNEXURE".

APPROVED TYPICAL BALCONY SCREEN

Plan / Front Elevation / Section

The balconies shall not be enclosed unless with approved balcony screen

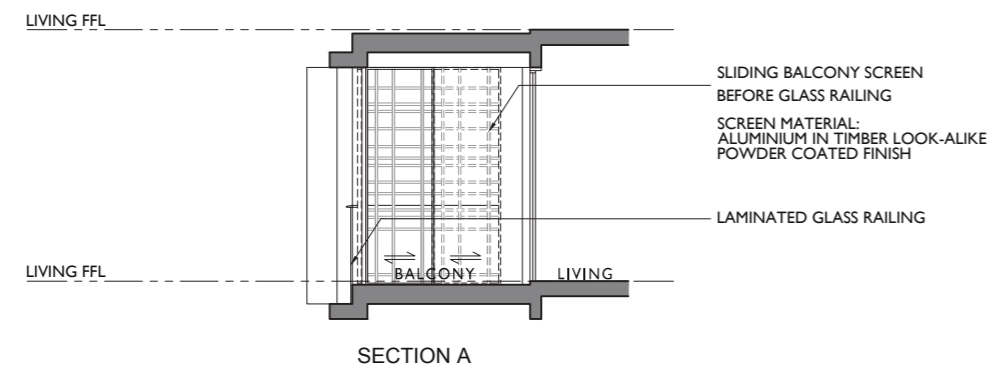
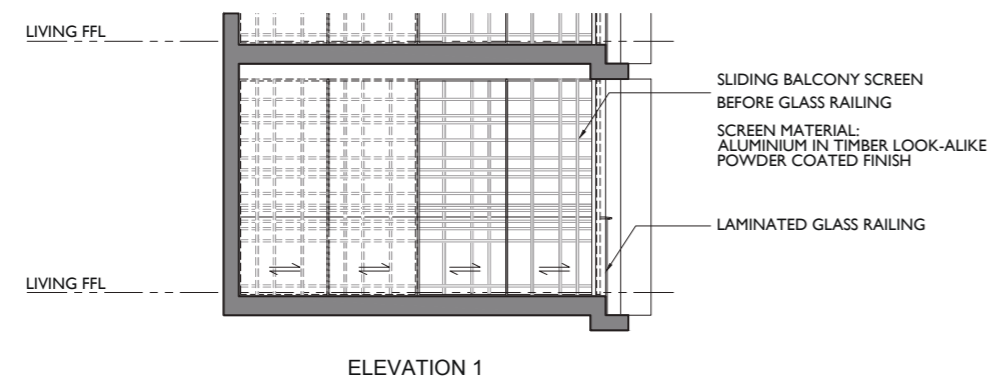
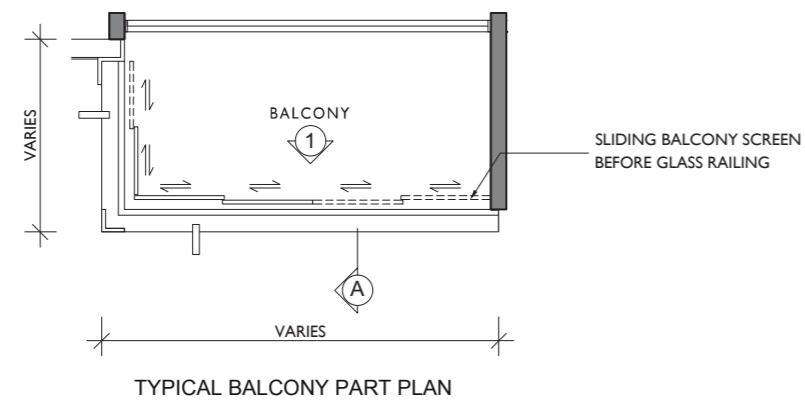

===== PROVIDED BY DEVELOPER
 ===== NOT PROVIDED BY DEVELOPER

This is a typical illustration. Please check with the developer and/or management corporation for the different screen configuration requirements for different unit types. The cost of the screen and installation shall be borne by the Purchaser. Mock-up sample of the approved balcony screen is displayed at the sales gallery for reference.

ABOUT THE DEVELOPER

Aurum is a space and business innovator with a focus on the future of people. It is the core of a trusted network of communities — creating opportunities across diverse industries for businesses, professionals and individuals seeking growth in Singapore and beyond.

Through an integrated lifestyle-led approach to Life, Work & Wellness, Aurum's various businesses include Aurum Land, Aurum Investments, Found8 and Core Collective. Aurum offers a 'golden ticket' to residents and members across the whole group, with exclusive lifestyle packages, preferential rates and special benefits for all our customers.



Incorporated in 1982, and a subsidiary of Woh Hup Holdings Pte Ltd, Aurum Land champions functionality and form in its designs to create exclusive and beautiful living spaces. Guided by innovative thinking and market insight, Aurum Land is managed by a team of passionate industry professionals, who bring with them extensive development expertise, design excellence and technical skill.

Our many design awards are testament to our unique and compelling design concepts, which are tailored to each development's site history and context. Beyond design trends, our developments are timeless in beauty, function and form.



Core Collective is a fitness and wellness hub that houses the best trainers and health professionals under one roof. Its professionals collaborate to deliver optimum results, helping clients to lead healthier and happier lives.

With a curated community of leading resident practitioners and best-in-class facilities, Core Collective tailor-makes an integrated and highly personalised palette of fitness and wellness services best suited to members' busy lifestyles. With a flagship space at Anson Road that was launched in April 2018, Core Collective is expanding to a second location in Dempsey with a sprawling outdoor space and wider service offerings to cater not only to urban professionals but to women and children as well.



Found8 sets a new benchmark for coworking in Asia driven with a vision to build the best innovation ecosystems, creating change, advancing communities and accelerating growth. We bring together an ever-growing network, beautiful spaces, and high touch customer services to consistently nurture game changing businesses that impact the world. At our core are our visionary communities, partners, and a true spirit of collaboration.

Found8 wants to be a force of change that leaves every individual and business better than when we found them.



ABOUT THE BUILDER

Founded in 1927, Woh Hup is one of Singapore's largest privately-owned construction and civil engineering specialists. Woh Hup has grown alongside the country and is privileged to have participated in many of the nation's iconic developments including MacDonald House, Wayang Satu Flyover, MRT Circle line projects, Reflections at Keppel Bay, Gardens by the Bay, The Interlace, Oasia Downtown Hotel and Jewel Changi Airport.

The company has forged strategic joint-venture partnerships with various overseas counterparts and is continuing to grow its presence locally and around the region. Woh Hup seeks to introduce innovative engineering solutions and incorporate new technologies that support sustainability to create more value for their clients.



PROPERTY AWARDS

EdgeProp Singapore Excellence Awards 2018
Top Boutique Development: THE ORIENT

FIABCI Singapore Property Awards 2017
Winner of Residential (Low Rise): THREE 11

FIABCI World Prix d'Excellence Awards 2017
Silver Winner of Residential (Low Rise): 1919

Asia Pacific Property Awards 2017
Best Apartment Singapore: THE ASANA

FIABCI Singapore Property Awards 2016
Winner of Residential (Low Rise): 1919

South East Asia Property Awards 2016
Highly Commended Boutique Developer Singapore

Asia Pacific Property Awards 2016
Highly Commended Apartment Singapore: THE ORIENT

South East Asia Property Awards 2015
Best Boutique Developer Singapore

Asia Pacific Property Awards 2015
Best Apartment Singapore: THREE 11

International Property Awards 2014
Best Apartment in the World: 1919

Asia Pacific Property Awards 2014
Best Apartment Asia Pacific: 1919

Asia Pacific Property Awards 2014
Best Apartment Singapore: 1919

Silver Residential I-DEA Award 2012: 1919

Developer: Aurum Land (Private) Limited (ROC No. 198204243D)
Developer's Licence No.: C1296
Location: Lots 00720C, 00559V TS26 at 11 Balmoral Road
Building Plan No.: A1960-00065-2018-BP01
Tenure of Land: Estate in Fee Simple - Freehold
Expected Date of Vacant Possession: 1 September 2022
Expected Date of Legal Completion: 1 September 2025
Encumbrances: Mortgage(s) in favour of United Overseas Bank Limited

ALL INFORMATION IN THIS BROCHURE IS CORRECT AT THE TIME OF PRINT

While reasonable care has been taken in the preparation of the brochure, the specifications and the attached plans, the developer and its agents shall not be held responsible for any inaccuracies or omissions. All statements, specifications and plans in the brochure are believed to be correct at the time of print but shall not be regarded as statements or representations of fact. Photographs and images contained in the brochure do not necessarily represent as built standard specifications. The developer reserves any and all copyright, design and other proprietary rights in and to this document (or any part thereof) including all or any part of the information, material or artwork contained therein. Unless otherwise expressly agreed to in writing, this document or any part thereof may not be copied, modified, distributed, reproduced or reused without the express written consent of the developer.

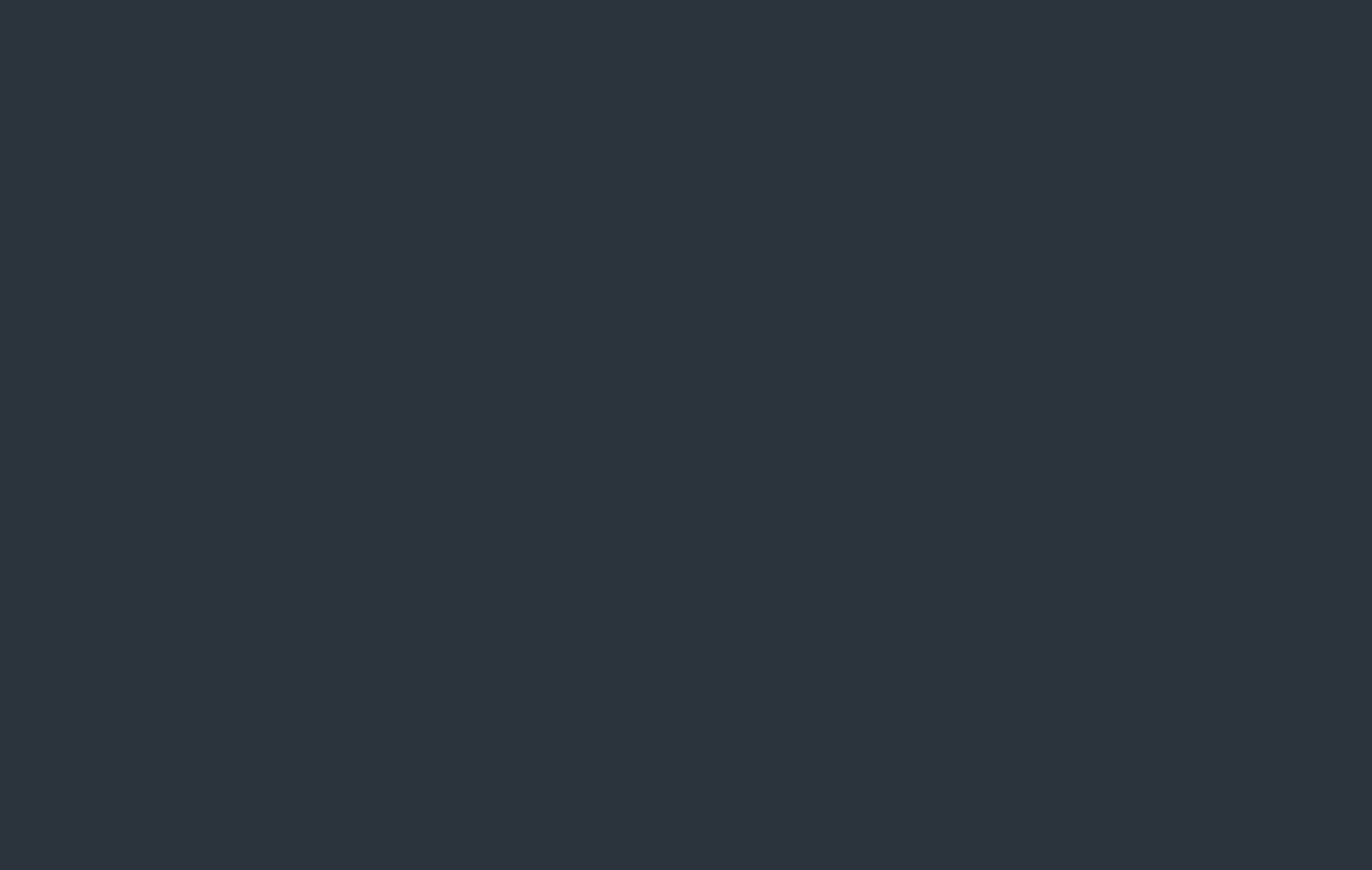

[AURUM.SG/THEHYDE](https://www.aurum.sg/thehyde)